

tyco

Electronics



Analogue Instruments

a vital part of your world

ENERGY DIVISION

Analogue Instruments

High quality analogue instruments designed to measure an extensive range of electrical and electronic parameters. This comprehensive range offers DIN instruments, ANSI switchboard meters, panel indicators, sealed and ruggedised instruments, and complementary selector switches for line-to-line and line-to-neutral readings. Instruments are precision engineered and robust in design, ensuring accurate measurement and display in the most demanding of environments. All instruments are available in a range of styles, sizes and specifications to meet the exacting needs of your industry.



Contents

DIN Panel Meters

An extensive range of 48, 72, 96 and 144mm DIN style panel meters. Short-scale ammeters, voltmeters and frequency meters incorporate slide-in dials and terminal covers. Long-scale meters are also available. Meters for power or energy contain in-built transducers and can be customised to suit many different system configurations and ranges.

Instrument Selector Switches

Panel mounted selector switches offering a 7-position voltmeter switch and a 4-position ammeter switch for reading line-to-line or line-to-neutral voltage and phase current.

070 Series ANSI Switchboard Meters

An extensive range of analogue and digital/analogue meters in 4½" and 8½" ANSI case styles. Meters utilise a high shock oil dampened movement, and provide 1% accuracy for all RMS AC and DC ranges. The range offers various customised options and features. UL, CSA, ABS and ISSeP approvals.

549 Series Panel Meters

Compact panel meters designed to fit standard 1½" switch knock-outs. The range offers high accuracy AC and DC ammeters and voltmeters, elapsed time meters and impulse counters. ABS approvals.

Saxon Series Panel Indicators

A range of 2½", 3½" and 4½" surface mount panel meters utilising taut band mechanisms and offering IP54 protection. The range offers iron vane and moving coil AC and DC ammeters and voltmeters, elapsed time and frequency meters. UL approvals.

016 Series Fiesta Panel Indicators

A robust range of short-scale and long-scale 3½" surface mount panel meters offering IP55 protection and featuring wide view-contoured windows. The range offers iron vane and moving coil AC and DC ammeters and voltmeters, elapsed time and frequency meters. UL approvals.

Challenger Series

Challenger analogue panel meters feature a detachable lower fascia plate, which allows either surface or window mounting. Meters use a high torque pivot and jewel movement.

078/080/087 Series Sealed and Ruggedised Indicators

Designed to comply with industrial, marine and military specifications, these 240° and 90° scale meters are resistant to extreme shock, vibration, temperature, dirt and humidity. The range offers a wide range of bezel sizes fitted with toughened glass.

Guide to Catalogue Numbering Systems and Glossary

Page

2 – 29

30 – 31

32 – 62

63 – 65

66 – 67

68 – 70

71 – 75

76 – 80

81 – 82

Features

- Extensive range
- Accurate measurement and display of electrical and electronic parameters
- Wide range of case styles and specifications
- Maximum reliability in harsh environments

Benefits

- Low cost
- Local indication
- Ease of installation
- Minimal training
- Low maintenance
- Reasonable accuracy

Applications

- Switchgear
- Distribution systems
- Generator sets
- Control panels
- Energy management
- Building management
- Utility power monitoring
- Process control
- Motor control

Approvals

UL, CSA, ABS, LRS, BV, ISSeP

Features

A range of the most popular short-scale measuring instruments in 4 case sizes
Shock resistant sprung pivot and jewel movement
Terminal covers supplied as standard
EMC hard frequency meter are fully EMC and LVD compliant
1/4" 'fast on' terminals available

Benefits

Low cost
Local indication
Ease of installation
Minimal training
Low maintenance
Customised options and features

Applications

Switchgear
Distribution systems
Generator sets
Control panels
Energy management
Building management
Utility power monitoring
Process control
Motor control

Approvals

Lloyds:
03/00055 - Moving coil meters
03/00056 - Moving iron meters
03/00057 - Frequency meters

DIN Panel Meters – Short scale

A range of 48, 72, 96 and 144mm DIN style panel meters measuring all electrical parameters and featuring moving coil or moving iron movements. All meters incorporate slide-in dials and terminal covers as standard. A range of customised options is available.

Movements

Moving Coil Meter

Centre cored, self shielding moving coil movement, using pivots, hairsprings and sprung jewels. Seven variations have been designed in movement ranges: all intermediate ranges are achieved by shunting the next lowest range. All DC voltmeters are 1000 ohms per volt, rectified product run at 900 ohms per volt, millivolt meters use the 5 milliamp movement.

Moving Iron Meter

Clapper type repulsion design using pivots, hairsprings and jewel movements. The bottom jewel is oil filled to provide damping while the top is sprung for resilience. All voltmeters are manufactured with external voltage dropper resistors to substantially reduce the self heating effects.

Frequency Meter

Meter uses a 100 microamp 4000 ohm movement driven by an EMC hard frequency conversion circuit.

Dials, Scales and Pointers

Standard dials are white matte with black printed scales and bar knife-edge pointers. Black dials with white or yellow scales and pointers are also available. Interchangeable slide-in dials are used on the E242, E243, E244 and 246 90° moving iron, moving coil and frequency meter models.

General options include red supplementary pointers, red indexes (quadrant scales), red, green or blue lines, bands or segments, finely spaced divisions, multi-scales, special scales and captions to customer' requirements.

Specifications

Type of instrument	Moving iron for current and voltage	Moving coil for current and voltage	Moving coil with rectifiers for current and voltage	Moving coil with built-in transducer for frequency measurement	Maximum demand indicators	Combined MDI with moving iron movement
Format	48 x 48mm 72 x 72mm 96 x 96mm 144 x 144mm	48 x 48mm 72 x 72mm 96 x 96mm 144 x 144mm	48 x 48mm 72 x 72mm 96 x 96mm 144 x 144mm	72 x 72mm 96 x 96mm 144 x 144mm	72 x 72mm 96 x 96mm	96 x 96mm
Movement type	Sprung pivot jewel with silicon oil damping	Sprung pivot jewel with eddy current damping	Sprung pivot jewel with eddy current damping	Sprung pivot jewel with eddy current damping	Sprung pivot jewel with silicon oil damping	Sprung pivot jewel with silicon oil damping
Burden	0.5VA - 15A then 0.8VA voltmeters 4.5VA	See detailed specifications	See detailed specifications	See detailed specifications	2.5VA	3VA
Accuracy	1.5% to DIN43780	1.5% to DIN43780	2.5% to DIN43780	0.5% to DIN43780	3% on MDI	3% on MDI 1.5% ammeter
Input type	AC current or voltage	DC current or voltage	Rectified AC current or voltage	Frequency for all voltage ranges	Mean RMS value and maximum demand current	Mean RMS value and maximum demand current and instantaneous current
Measuring range	6 - 600V 100mA - 100A	15mV - 600V 25µA - 100A	6 - 600V 100µA - 100mA	57.7V @ 45Hz 500V @ 44Hz	1 - 6A 8, 15 or 20 minute delays	1 - 6A 8, 15 or 20 minute delays 0 - 5A/6A instantaneous
Dielectric voltage withstand test	3kV AC	3KV AC	3KV AC	3KV AC	3KV AC	3KV AC



General Specifications

Performance	BSEN60051
Measuring ranges	DIN 43701
Accuracy overload	BSEN60051
Dimensions	DIN43700
Scale marking generally to	DIN43802
Magnetic influence	BSEN60051
Safety	BSEN61010-1
Terminals	Clamp strap M4 for up to 25A. Clamp strap M8 for over 25A. 1/4" spade terminals available for models E243 and E244
Humidity range	Up to 95% RH (non condensing)
Test voltage @50Hz	3kV RMS for 1 minute
Ammeter ranges	1.0/1.2/1.3/1.5/2.5/4/5/6/8 and decade multiples thereof.
Overload AC current	x 1.2 continuous x 10 for 5 seconds
AC voltage and frequency	x 1.2 continuous x 2 for 5 seconds
Standard calibration	23°C. Calibration at other temperatures available on request
Operating temperature	-20°C to +60°C
Damping time	Less than 3 seconds
Enclosure code	IP52 as standard IP54 on request
Case and base	Grade UL94V0 (Lexan 500R)
Case	Dimensions and panel cutout conform to IEC473, DIN 43700. Case made from glass filled polycarbonate self-extinguishing and non drip in accordance with UL94 V-O.
Bezel	Slim-line DIN43802, black as standard
Bezel window	Standard sheet glass, with zero adjusters where appropriate. Non reflecting glass or polycarbonate shatterproof windows are available.
Installation	Installations in switchboard panel or mosaic arrangement on equipment or machine with a panel thickness of up to 40mm in a horizontal or vertical plane
Fixing on panel	Swivel captive fasteners, which can be fixed at either corner.
Mounting position	Normal vertical mounting or as indicated on the scale in accordance with DIN 16257. A deviation of $\pm 15^\circ$ is permissible
Insulation group	Insulation resistance more than $5M\Omega @ 500 V$
Environmental	Measurement category III IEC 1010-1 Pollution degree 2 IEC 1010-1 Electrical rating 600V RMS (920V peak)
Approvals	EMC, LVD and Lloyds

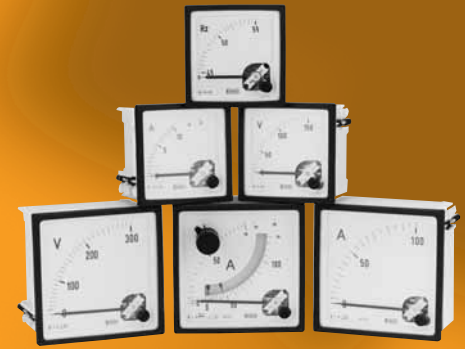

DIN 16257 symbol meaning for calibration position

Vertical



Horizontal

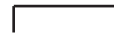

Inclined

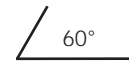

Inclination of dial surface.

Required orientation must always be stated when ordering if other than vertical mounting is required.

Dimensions

Moving coil measuring range		Moving iron measuring range	
6 - 60A	C=67mm	0 - 30A	C=64mm
>60A	C=78mm	>30A	C=67mm

Max. panel thickness = 40mm

D	A	B
48 x 48	45 x 45	4
72 x 72	68 x 68	4
96 x 96	92 x 92	4
144 x 144	135 x 135	4

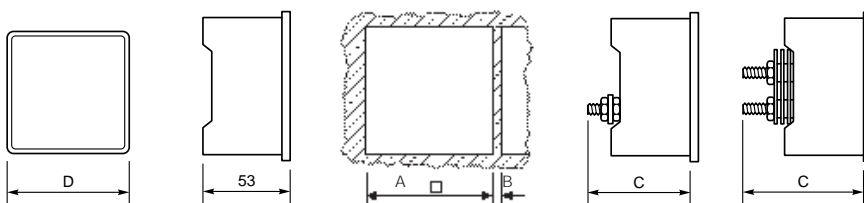



DIN Panel Meters – Short scale

Moving Iron AC Ammeters and Voltmeters

Designed to measure AC current or voltage, these meters indicate true RMS values and are substantially independent of system waveform. Scales are calibrated down to 20%, and ammeters can have overload scales of x2, x3, x5 or x6 for motor start duty. Ammeters can be supplied for use with -/1A or -/5A current transformers, whilst voltmeters can be scaled for use with voltage transformers. Heavy damping is available as an option. Meters can be used to measure DC at reduced accuracy.

Connections

AC Ammeter

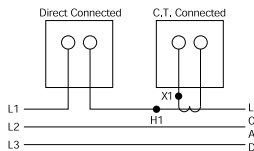
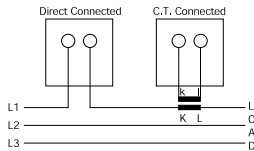

AC Voltmeter

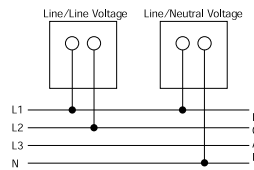

Specifications

Accuracy:	Class 1.5
Frequency:	50 or 60Hz, (400Hz on request)
Burden at 50Hz:	Ammeters: 0.5VA voltmeters: Up to 4.5VA maximum
Ratings:	Ammeters: 0.5 - 100A AC direct connected (40A for E242-75A and E246-07A). Maximum system voltage 600V AC Low load / high middle, maximum 10A
Voltmeters:	6 - 600V

Product Codes

Bezel size mm	48	72	96	144
Scale length mm	42	65	94	145
Product codes				
AC ammeter	E242-75A	E243-02A	E244-02A	246-071A
x2 overload ammeter	E242-752A	E243-022A	E244-022A	246-072
x3 overload ammeter	E242-753A	E243-023A	E244-023A	246-073
x5 overload ammeter	E242-755A	E243-025A	E244-025A	246-075
x6 overload ammeter	E242-756A	E243-026A	E244-026A	246-076
AC voltmeter	E242-75V	E243-02V	E244-02V	246-07V



Frequency Meters

Frequency meters use an integral electronic converter and a moving coil indicator. These easy to read meters are Class 0.5 accurate.

Connections

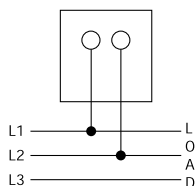

Specifications

Ratings:	100-125V AC 200-250V AC 380-440V AC* 500V AC*
Frequency:	0.5%: 45/55Hz, 55/65Hz, 45/65Hz, 360/440Hz
Burden:	4VA maximum
	*Use E242-013 and 253-THZ in place of E242-41S for voltages over 380V Models available for use with VTs

Product Codes

Bezel size mm	48	72	96
Scale length mm	42	65	94
Product codes	E242-41S	E243-41S	E244-41S

Maximum Demand Indicators

The thermal/time characteristics of MDI meters monitor the most economic use of cable, fusegear and transformers. The directly heated bimetal element indicates mean RMS current over 8, 15, or 20 minutes, and a red slave pointer shows the highest value reached. The reset knob is wire sealable. Scales are calibrated to match the CT primary plus 20% overload. End values are selected from: 1.2, 1.8, 2.4, 3, 3.6, 4.8, 6, 7.2, 9 amps and their multiples of 10 and 100.



Specifications

Accuracy:	Class 3
Options:	5A for use with separate CT 5/5A saturating CT 1/5A saturating CT
Burden at 50 Hz:	MDI - 2.5VA, CT - 2VA
Overload withstand:	Standard: 5 x FL for 5 seconds, 10 x FL for 1 second. With saturating CT: 10 x FL for 3 seconds, 20 x FL for 1 second
Frequency:	50/60Hz

Product Codes

Bezel size mm	72	96
Scale length mm*	65	94
Product codes		
8 minute time lag		
without limiting CT for use with 5A CT	E243-16B	E244-16B
15 minute time lag		
without limiting CT for use with 5A CT	E243-16A	E244-16A
20 minute time lag		
without limiting CT for use with 5A CT	E243-16J	E244-16J

* Scaled 0/100/120% of CT primary value.

Connections

Maximum Demand Indicators

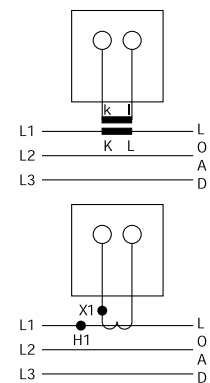

Combined AC Ammeter and Maximum Demand Indicator

Where measurement of instantaneous and maximum demand currents are required, these instruments combine both movements in one case. The meter can also replace an existing AC ammeter. Meets the same specifications listed above.

Specifications

Accuracy:	Moving iron ammeter: Class 1.5 MDI: Class 3
Burden at 50Hz:	MI - 0.5VA, MDI - 2.5VA saturating CT - 2VA

Product Codes

Bezel size mm	72	96
Scale length mm*	65	94
Product codes		
8 minute time lag		
without limiting CT for use with 5A CT 3VA	-	E244-16Q
15 minute time lag		
without limiting CT for use with 5A CT 3VA	E243-16C	E244-16C
20 minute time lag		
without limiting CT for use with 5A CT 3VA	-	E244-16H

* Scaled 0/100/120% of CT primary value.





Moving Coil DC Ammeters and Voltmeters

Moving coil meters are suitable for all DC systems. The linear scale is calibrated down to zero and the accuracy maintained down to 10%. High currents are measured with separate shunts and suitably scaled indicators. Suppressed, centre and offset zero models are available.

Connections

DC Voltmeter

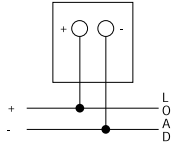

DC Ammeter

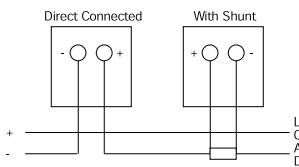

Specifications

Accuracy:	Class 1.5
Ratings:	Ammeters: 100 μ A-25A, (200 μ A for long-scale model) 4/20mA suppressed zero 40A for model E242, E243 and E244 up to 100A Voltmeters: 50mV-600V 1/5V suppressed zero 50, 60, 75, 100, 150mV for use with shunts
Impedance:	Ammeters: 75mV internal shunt above 60mA Voltmeters: 1000 Ω /V above 1V

Product Codes

Bezel size mm	48	72	96	144
Scale length mm	42	65	94	145
Product codes				
Ammeters	E242-89A	E243-01A	E244-01A	246-10A
Ammeters suppressed zero	E242-89R	E243-01R	E244-01R	246-10
Voltmeters	E242-89V	E243-01V	E244-01V	246-10V
Voltmeters suppressed zero	E242-89S	E243-01S	E244-01S	246-10S



Moving Coil Rectified AC Ammeters and Voltmeters

For high frequency or linear full scale AC measurements, these instruments measure average values of sinusoidal waveforms and are scaled in RMS values. The high quality silicon bridge rectifier gives a linear scale down to near zero, where some compression occurs.

Connections

AC Ammeter

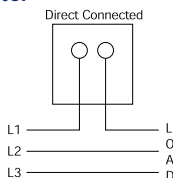

AC Voltmeter

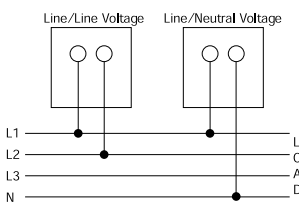

Specifications

Accuracy:	1.5% ES
Ratings:	Ammeters: 250 μ A-1A AC Over 1A via CTs Voltmeters: 15 - 600V AC direct connected. models available for use with VTs
Frequency:	50/60Hz, (Single frequencies 25Hz - 3kHz on request)

Product Codes

Bezel size mm	48	72	96	144
Scale length mm	42	65	94	145
Product codes				
Ammeters	E242-89B	E243-01B	E244-01B	246-10B
Voltmeters	E242-89W	E243-01W	E244-01W	246-10W

Process Indicators

Meters are used to check process functions locally or remotely at centralised controls. These moving coil instruments offer a wide variety of electrical and mechanical readouts and are operated by transducer, tachogenerator, thermocouple, resistance bulb or other DC analogue signals. Suppressed, centre and offset zero models are available on request.

Specifications

Accuracy:	Class 1.5
Ratings:	1, 2, 5, 10, 20mA 4/20mA suppressed zero

Product Codes

Bezel size mm	48	72	96	144
Scale length mm	42	65	94	145
Product codes				
AC current	E242-89A	E243-01A	E244-01A	246-10A
AC voltage	E242-89V	E243-01V	E244-01V	246-10V
Speed	E242-892	E243-012	E244-012	246-102
Frequency	E242-893	E243-013	E244-013	246-103
Phase angle	E242-894	E243-014	E244-014	246-104
Watts	E242-895	E243-015	E244-015	246-105
VAr	E242-896	E243-016	E244-016	246-106
VA	E242-897	E243-017	E244-017	246-107



Connections

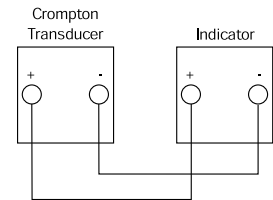



DIN Panel Meters – Long-Scale

An extensive range of 48, 72, 96 and 144mm DIN style panel meters measuring all electrical and electronic parameters. Meters are shock resistant and vibration proof and supplied with terminal covers. A selection of slide-in dials and customised options are available.

Features

Extensive range of specialist meters in four case sizes
 Shock resistant taut band suspension
 Vibration-proof Hi-Q damping
 Slide-in dials for 90° current, voltage and frequency on models 242, 243 and 244
 Terminal covers supplied as standard

Benefits

Low cost
 Local indication
 Ease of installation
 Minimal training
 Low maintenance
 Customised options and features

Applications

Switchgear
 Distribution systems
 Generator sets
 Control panels
 Energy management
 Building management
 Utility power monitoring
 Process control
 Motor control

Approvals

LRS and BV

Movements

In Crompton Instruments' patented 'Hi-Q' taut band suspension, all the delicate parts of the traditional instruments are eliminated. There are no pivots, no jewel bearings, no hair-springs and no air damping vane. Instead, a tough platinum ribbon suspends the moving element between front and rear tension springs. Specially contoured pads are fitted to the ends of the spindle, and the working gap at each end is filled with a high quality silicon fluid. The pads, together with the fluid reservoir, form a system which acts as a resilient built-in shock absorber. This provides both rotational and longitudinal damping as the moving element floats on oil with no bearing friction and is effectively cushioned against shock and vibration. 360° synchrosopes and power factor meters have robust pivot and jewel bearings with oil damping.

Dials, Scales and Pointers

Standard dials are white matte with black printed scales and bar knife-edge pointers. Black dials with white or yellow scales and pointers are also available. Interchangeable slide-in dials are used on model numbers 242, 243 and 244 90° moving iron, moving coil and frequency meters.

General options include red supplementary pointers, red indexes (quadrant scales), red, green or blue lines, bands or segments, finely spaced divisions, multi-scales, special scales and captions to customer' requirements.

Illumination

Meters come with a full range of illumination options. Internal illumination is available in the following models:

- 244 and 246 short-scale moving coil and moving iron vane.
- 243, 244 and 246 long-scale moving coil and moving iron vane.

Through-dial (translucent) illumination on 244 and 246 models. Edge illumination on 243, 244 and 246 models. Replaceable 6, 12 or 24V lamps are used on all models except 243 long-scale meters, where the lamps are internal.

Specifications

Performance	BSEN60051
Measuring ranges	DIN 43701
Accuracy overload	BSEN60051
Dimensions	DIN 43700
Scale marking generally	DIN43802
Magnetic influence	BSEN60051
Safety	IEC414
Terminals	Clamp strap M4 up to 25A. Clamp strap M8 for over 25A
Humidity range	Up to 95% RH (non condensing)
Test voltage @50Hz	2kV RMS for 1 minute
Overload AC current	x 1.2 continuous x 10 for 5 seconds
Overload AC voltage	x 1.2 continuous x 2 for 5 seconds
Frequency	See main pages for other instruments
Damping time	Less than 3 seconds is standard. More heavily damped movements are available on request.
Standard calibration	23°C
Operating temperature	-20°C to -60°C
Enclosure code	IP54 as standard (to BSEN60529). For IP55 consult with factory. Terminals IP20B with terminal cover or terminal boots fitted
Case	Grade UL94V0
Base	Grade UL94V1



Specifications Continued

Case	Dimensions and panel cutout conform to IEC473, DIN 43700. Models 242, 243 and 244 have injection moulded cases and bezels in flame retardant engineering thermoplastic, recognised by Underwriters Laboratory materials specifications. All 246 models have pressed steel cases.
Bezel	Slim-line DIN43802, black as standard
Bezel window	Standard sheet glass, with zero adjusters where appropriate. Non reflecting glass or polycarbonate shatterproof windows are available.
Installation	Installations in switchboard panel or mosaic arrangement on equipment or machine with a panel thickness of up to 40mm in a horizontal or vertical plane. Installation Category III
Fixing on panel	Models 242, 243 and 244 – 2 corner fixing clamps and tensioning thumb screws. Model 242 – available with a one piece 'push on' clamp. Model 246 – 2 side fixing spring clips.
Mounting position	Normal vertical mounting or as indicated on the scale in accordance with DIN 16257. A deviation of $\pm 15^\circ$ is permissible.
Approvals	Lloyds Shipping (LRS), Bureau Veritas (BV), EMC and LVD

DIN 16257 symbol meaning for calibration position

Vertical



Horizontal



Inclined

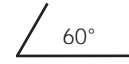

Inclination of dial surface from a horizontal plane, e.g. 60°
Required orientation must always be stated when ordering if other than vertical mounting is required.

Dimensions

Model	242	243	244	246
Bezel 'A'	48 x 48	72 x 72	96 x 96	144 x 144
Panel cut-out 'B'	45 x 45	68 x 68	92 x 92	138 x 138
Scale length: 90°	42	65	94	145
Scale length: 240°	72	112	150	230
Maximum overall depth 'C':				
Ammeters and voltmeters AC and DC*	64	64	64	60
Ammeters and voltmeters with switch*	-	-	64	-
Dual meters*	-	-	64	-
Elapsed time meter/hours run*	64	64	64	-
Maximum demand indicator*	-	64	64	60
Combined MDI and MI indicator*	-	-	64	60
Maximum demand indicator with relay*	-	-	90	-
Frequency meter 90° *	64	64	64	60
Frequency meter 240° *	§	§	120	125
Phase angle, power factor meter 90° *	§	§	107	§
240°*	§	§	107	§
M.C. indicator with separate transducer*	64	64	64	60
Dynamometer 360° synchroscope*	-	-	120	125
Dynamometer 360° power factor meter*	-	-	120	-
Phase sequence indicator*	-	64	64	-
Position indicator*	§	§	120	125
Speed indicator*	64	64	64	60
Temperature indicators*	-	-	120	125
Quadra meters*	-	-	64	-
Impulse counters*	64	64	64	-
Wattmeter, VARmeter 90°	§	§	107	125
Wattmeter, VARmeter 240°	§	§	107	125
Model 244-21Y and 244-21Z	-	-	142	-
LED synchroscope and synchro check relay	-	-	80	-
LED 360° synchroscope	-	-	80	-

§ Indicator only

* If separate terminal cover is used, add 20mm to dimension C.

- Not available

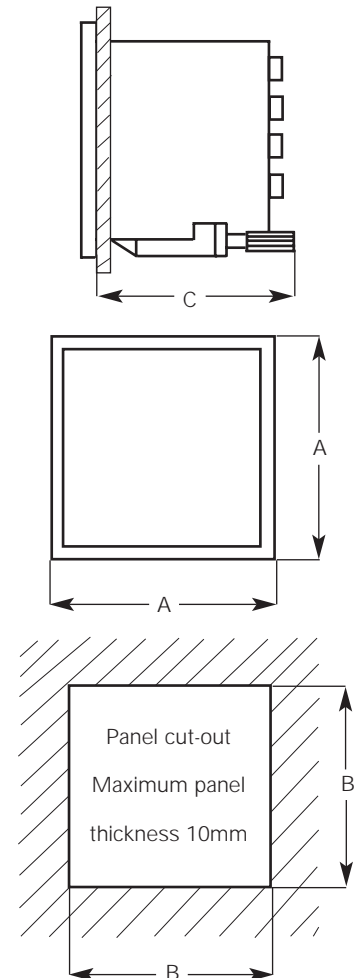



Moving Iron AC Ammeters and Voltmeters

Designed to measure AC current or voltage, these meters indicate true RMS values and are substantially independent of system waveform. Scales are calibrated down to 20%, and ammeters can have overload scales x2, x3, x5 or x6 for motor start duty. Ammeters can be supplied for use with -/1A or -/5A current transformers, whilst voltmeters can be scaled for use with voltage transformers. Heavy damping is available as an option. Meters can be used to measure DC at reduced accuracy.

Connections

AC Ammeter

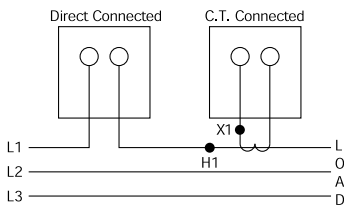
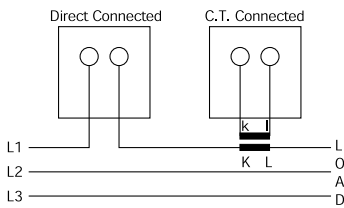

AC Voltmeter

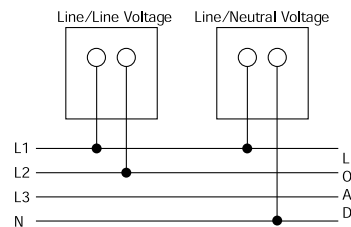

Specifications – Long-Scale Meters

Accuracy:	Class 1.5
Frequency:	50 or 60Hz, (400Hz on request)
Burdens at 50Hz:	Ammeters: 1.5VA Voltmeters: 4.5VA maximum
Ratings:	Ammeters: 0.5 - 25A AC DC Maximum system voltage 720V AC Low load / high middle (maximum 10A) Voltmeters: 6 - 600V AC

Product Codes – Long Scale

Bezel size mm	48	72	96	144
Scale length mm	72	112	150	230
Product codes				
Ammeter	242-03A	243-03A	244-03A	246-03A
x2 overload ammeters	242-032	243-032	244-032	246-032
x3 overload ammeters	242-033	243-033	244-033	246-034
x5 overload ammeters	242-035	243-035	244-035	246-035
x6 overload ammeters	242-036	243-036	244-036	246-036
Low load ammeters	-	243-03H	244-03H	-
Voltmeter	242-03V	243-03V	244-03V	246-03V

DIN Panel Meters – Long scale and Dual

Frequency Meters

Frequency meters use an integral electronic converter and a moving coil indicator. These meters are easy to read with an accuracy of Class 0.5.

Specifications

Accuracy:	Class 0.5
Ratings:	100-125V AC 200-250V AC 380-440V AC* 500V AC* *For voltages above 380V, use 242-013 substituting 253-THZ, in place of 242-41S. Models available for use with VTs.
Frequency 0.5%:	45/55Hz, 55/65Hz, 45/65Hz, 360/440Hz Other scalings available on request.
Burden:	4VA maximum

Product Codes

Bezel size mm	48	72	96	144
Scale length mm	72	112	145	
Product codes	242-053	243-053 +253-THZ	244-41L	246-41L +253-THZ

Connections

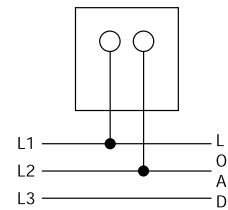

Dual AC Ammeters and Voltmeters

The two instruments in one case can be used for the independent measurement of two parameters or the comparison of two inputs. Often used when an AC generator is to be connected in parallel with mains supply where voltage, phase and frequency must coincide.

Specifications

Accuracy:	1.5% ES
Ratings:	Ammeter: 250 μ A - 10A AC Voltmeter: 15 - 600V direct connected
Frequency:	50/60Hz (single frequencies 25Hz to 3kHz on request)

Product Codes

Bezel size mm	96
Scale length mm	65
Product codes	
Ammeters	244-80F
Voltmeters	244-80L



Dual AC Ammeter Direct Connected

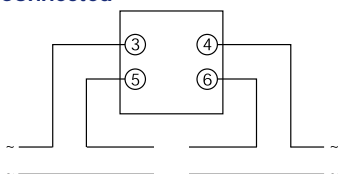

Dual AC Voltmeter

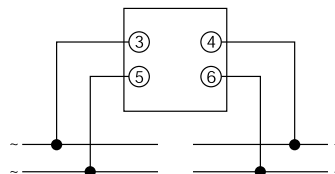



DIN Panel Meters – Long-Scale and Dual

Moving Coil Rectified AC Ammeters and Voltmeters

For high frequency or linear full scale AC measurements, these instruments measure average values of sinusoidal waveforms and are scaled in RMS values.

The high quality silicon bridge rectifier gives a linear scale down to near zero, where some compression occurs.

Connections AC Ammeter

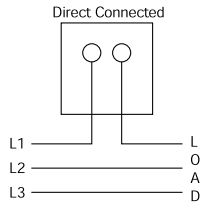

AC Voltmeter

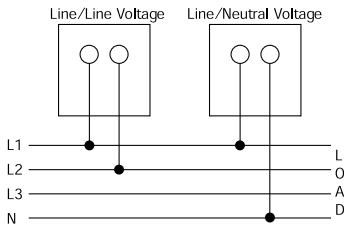

Specifications – Long-Scale

Accuracy:	1.5-% ES
Ratings:	Ammeters: 250µA-1A AC. Up to 30A on models 244/246-05B Voltsmeters: 15 - 600V direct connected Models available for use with VTs
Frequency:	50/60Hz. (Single frequencies 25Hz to 3kHz on request)

Product Codes – Long-Scale

Bezel size mm	48	72	96	144
Scale length mm	72	112	150	230
Product codes				
Ammeters	242-05B	243-05B	244-05B	246-05B
Voltsmeters	242-05W	243-05W	244-05W	246-05W



Dual Frequency Meters

Two instruments in one case can be used to measure a wide range of frequencies. These dual instruments save both panel space and assembly time. The 244-41D is an ideal component in synchronising applications.

Connections

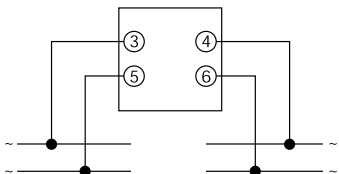

Specifications

Accuracy:	Class 0.5
Ratings:	100 - 125V AC 200 - 250V AC 380 - 440V AC 500V AC Models available for use with VTs
Frequency 0.5%:	45/55Hz, 55/65Hz, 45/65Hz, 360/440Hz
Burden:	4VA maximum

Product Code

Bezel size mm	96
Scale length mm	65
Product code	244-41D

DIN Panel Meters

Moving Iron AC Ammeters and Voltmeters with Selector Switch

Crompton Instruments, a business unit of Tyco Electronics, is pleased to add the new moving iron AC ammeter and voltmeter with selector switch to its comprehensive range of panel meters. These 96mm and 72mm units offer Class 1.5 true RMS measurement of three-phase AC voltage or current with various switch notation options. The integral selector switch eliminates the necessity for a separate selector switch, saving valuable panel space and providing installation benefits. Both ammeters and voltmeters feature a slide-in dial, scaled for VT or CT values to suit application primary values.

These robust moving iron meters incorporate a clapper type repulsion design which utilises a pivot, hairspring and jewel movement. The bottom jewel is oil filled to provide damping while the top is sprung for resilience. Voltmeters are manufactured with internal voltage dropper resistors.



Product Codes – AC Ammeters with Selector Switch

Code	Case size	Full scale deflection	Switch notation
E243-02E-G-LS**-C7-AMP3	72mm	0/5 A AC	OFF L1 L2 L3
E244-02E-G-LS**-C7-AMP3	96mm	0/5 A AC	OFF L1 L2 L3
E243-022E-G-LS**-C7-AMP3	72mm	0/5/10A AC	OFF L1 L2 L3
E244-022E-G-LS**-C7-AMP3	96mm	0/5/10A AC	OFF L1 L2 L3
E243-02E-G-LA**-C7-AMP3	72mm	0/1 A AC	OFF L1 L2 L3
E244-02E-G-LA**-C7-AMP3	96mm	0/1 A AC	OFF L1 L2 L3
E243-022E-G-LA**-C7-AMP3	72mm	0/1/2A AC	OFF L1 L2 L3
E244-022E-G-LA**-C7-AMP3	96mm	0/1/2A AC	OFF L1 L2 L3

**Insert applicable CT primary value.

Product Codes – AC Voltmeters with Selector Switch

Code	Case size	Full scale deflection	Switch notation	3-Phase
E243-02Q-G-PM**-C7-SW6	72mm	0/120 V AC	OFF L1L2 L2L3 L3L1	3W
E243-02Q-G-PZ**-C7-SW6	72mm	0/150 V AC	OFF L1L2 L2L3 L3L1	3W
E243-02Q-G-PZ-PZ-C7-SW6	72mm	0/150 V AC	OFF L1L2 L2L3 L3L1	3W
E243-02Q-G-RX-RX-C7-SW6	72mm	0/300 V AC	OFF L1L2 L2L3 L3L1	3W
E243-02Q-G-SF-SF-C7-SW3	72mm	0/500 V AC	L1L3 L1L2 L2L3 L3N L2N L1N	4W
E243-02Q-G-SJ-SJ-C7-SW3	72mm	0/600V AC	L1L3 L1L2 L2L3 L3N L2N L1N	4W
E244-02Q-G-PZ**-C7-SW6	96mm	0/150 V AC	OFF L1L2 L2L3 L3L1	3W
E244-02Q-G-PZ-PZ-C7-SW6	96mm	0/150 V AC	OFF L1L2 L2L3 L3L1	3W
E244-02Q-G-RX-RX-C7-SW6	96mm	0/300 V AC	OFF L1L2 L2L3 L3L1	3W
E244-02Q-G-SF-SF-C7-SW3	96mm	0/500 V AC	L1L3 L1L2 L2L3 L3N L2N L1N	4W
E244-02Q-G-SF-SF-C7-SW3	96mm	0/600V AC	L1L3 L1L2 L2L3 L3N L2N L1N	4W

**Insert applicable VT primary and secondary value, e.g. 15kV/110V.

Product Codes – Options

Description
Non reflecting glass window
Polycarbonate shatterproof window
Red supplementary pointer, externally adjustable
Red index mark (triangle)

Please state any required options at time of ordering.

Features

- Integral selector switch
- True RMS measurement
- Slide-in dials
- Scaled for customer VT or CT primary values
- DIN 72 and DIN 96 models
- Terminal cover as standard
- Shock resistant sprung pivot and jewel movement
- x2 overload ammeters

Benefits

- Space and time saving
- Competitive cost
- Local indication
- Ease of installation
- Low maintenance
- Customised options and features

Applications

- Switchgear
- Distribution systems
- Generator Sets
- Control panels
- Energy management
- Building management

Compliant with

IEC61010-1B2001, EMC and LVD



Connections

AC Ammeters with Selector Switch

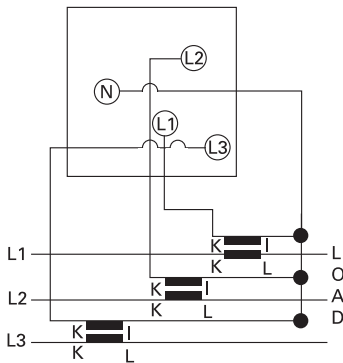

AC Voltmeters 3-Phase 3-Wire

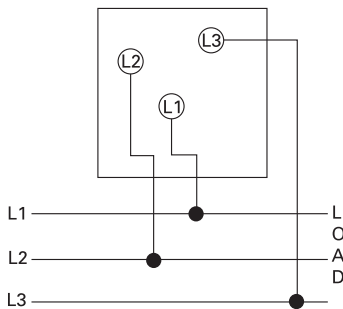

AC Voltmeters 3-Phase 4-Wire

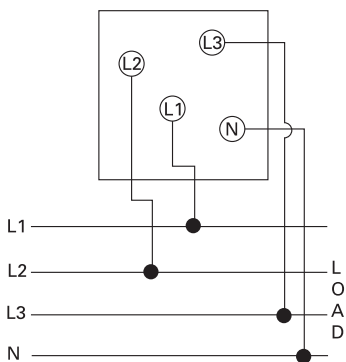

Specifications

Accuracy:	1.5% of full scale deflection (FSD)
Input rating:	Ammeter: 1A, 5A 1/2A or 5/10A moving iron, direct connected Voltmeter: 120, 300, 500 and 600V AC
Frequency:	50 or 60Hz (400Hz on request)
Burden at 50Hz:	Ammeters: 0.5VA Voltsmeters: 4-5VA max
Overload ammeter:	2 x In continuous for 2 minutes, 4 x In for 1 minute
Overload voltmeter:	1.2 x continuous 2 x for 5 seconds
Movement:	Moving iron shock resistant sprung pivot and jewel
Scale length:	DIN72: 54mm DIN96: 97mm
Enclosure style:	Panel mount to DIN 42700
Enclosure material:	Grade UL94 VO (Lexan 500R)
Bezel style:	Black matte DIN43802
Window:	Standard sheet glass
Terminals:	M4 captive screw clamp
Fixing:	2 corner fixing clamps with tensioning thumb screws
Mounting position:	Vertical mount to DIN 16257, inclination of dial surface $\pm 15\%$
Damping time:	
Compliant with:	IEC61010-1B2001, CAT III 600V, EMC and LVD
Operating temperature:	-20 to +55°C
Storage temperature:	-40 to +75°C
Calibration temperature:	23°C
Relative humidity:	95% (non condensing)
Dimensions:	96DIN: 96mm high x 96mm wide x 63mm deep 72DIN: 72mm high x 72mm wide x 63mm deep
Panel cut-out:	DIN96: 92mm x 92mm DIN72: 68mm x 68mm
IP protection:	IP40
Weight:	E243-02E 275g E243-02Q 300g E244-02E 360g E244-02Q 390g

Dimensions

72DIN Models

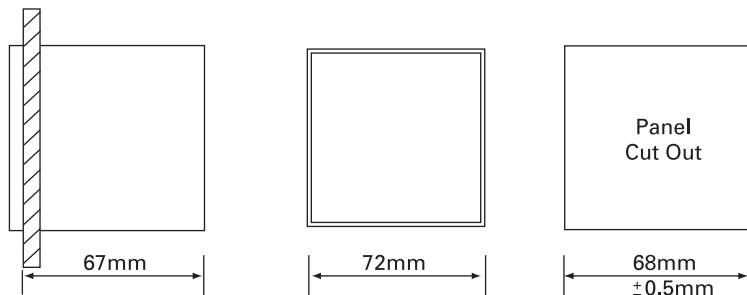

96DIN Models

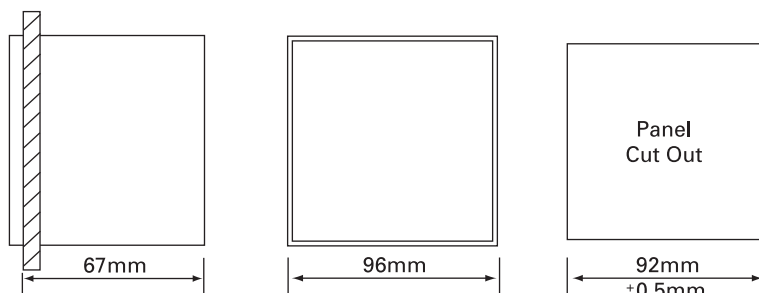

DIN Panel Meters – ETM and Impulse Counters

Elapsed Time or Hours Run Meters

Elapsed time meters (ETM) or hours-run meters monitor "ON/RUN" time of plant and equipment, allowing the user to effectively control production efficiency, cost estimation and service period monitoring for preventative maintenance. Time is measured in increments of 0.01h up to 99999.99 hours after which the meter automatically resets to zero. Meters are non resettable before this time to prevent accidental resetting.



Specifications

Display:	99999.99
Voltage:	100-125V AC 200-250V AC 380-440V AC
Frequency:	50 or 60Hz
Burden:	2.5VA for DC input models
Voltage:	10/27V (12, 24V) DC 38/58V (48V) DC 90/132V (110V) DC

Product Codes

Bezel size mm	48	72	96
Scale length	99999.99h	99999.99h	99999.99h
Product codes			
50Hz	242-158	243-155	244-155
60Hz	242-159	243-156	244-156
DC input	242-157	243-151	244-151

Connections

Elapsed Time/Hours Run Meters AC

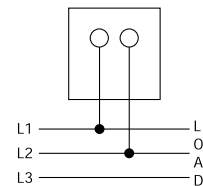

Elapsed Time/Hours Run Meters DC

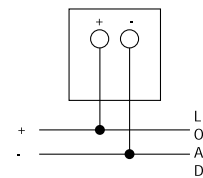

Impulse Counters

Impulse counters can be used to measure any parameter where there is an applicable pulse that is directly proportional to the measured parameter. For example, the number of motor starts can be recorded by using a combination of Paladin transducers, kWh, ampere hour, VA hour. The counter registers one digit every time an on/off voltage pulse is applied to the input terminals, and is non resettable to prevent accidental resetting.

Specifications

Accuracy:	Pulse for pulse
Display:	6 digit 999999
Ratings:	110, 120, 220, 230, 240, or 415V AC±10% 50/60Hz 12V or 24V DC ±10%
Burden:	0.75VA (110V AC) 2.70VA (415V AC) 80mW (12V DC)
Pulse width:	50ms minimum
Mark/space ratio:	1:1

Product Codes

Bezel size mm	48	72	96
Scale length	999999	999999	999999
Product codes			
DC input			
12V	242-259G-MU	243-259G-MU	244-259G-MU
24V	242-259G-BD	243-259G-BD	244-259G-BD
AC input			
110V	242-259G-PM	243-259G-PM	244-259G-PM
120V	242-259G-PQ	243-259G-PQ	244-259G-PQ
220V	242-259G-R4	243-259G-R4	244-259G-R4
230V	242-259G-RQ	243-259G-RQ	244-259G-RQ
240V	242-259G-RR	243-259G-RR	244-259G-RR
380V	242-259G-RU	243-259G-RU	244-259G-RU
415V	242-259G-SB	243-259G-SB	244-259G-SB





DIN Panel Meters – Quadra

Quadra 3-in-1 and 4-in-1

The Quadra range of 96mm² DIN style 3-in-1 and 4-in-1 meters offer reduced stock holding and savings on space, installation and commissioning. Ideally suited for generator set applications, the range offers measurement of AC and DC, current and voltage, frequency or elapsed time. Options include customer logo on dial, coloured dial, panel mounting gasket and heavily dampened movements.

Specifications

Voltmeter:	110, 120, 200, 230, 240, 380, 400, 415, 440, 480V AC nominal. Maximum end scale 600 volts
Frequency meter inputs:	45/55Hz, 55/65Hz, 45/65Hz, 360/440Hz Voltage inputs: Same as voltmeter inputs above
Ammeter inputs:	10mA AC 1 or 5A input (internal CT)
Hours run:	110, 120, 220, 230, 240, 380, 400, 415, 440 volts 50 or 60Hz
Hour run counting range:	99999.99 hours
DC current:	250µA - 1A DC including 1, 5, 10, 20 and 4-20mA DC for transducer inputs
DC volts:	50mV to 600V DC including 50, 60, 75 and 150mV for shunt inputs
Burden:	Current: 0.75VA per phase Hours run: 2.5VA LCD hours run: 0.5VA Voltage: 0.5VA Frequency: 4VA

When ordering please specify the inputs for each parameter and the scaling required.

Product Codes

Code	Description
244-80C	ACV + DCI + ACA + DCA
244-80D	3 x DCI + DC ETM (LCD)
244-80G	3 x ACA
244-80H	3 x ACV + FRQ
244-80I	3 x ACA + ETM
244-80J	3 x ACA + ETM (LCD)
244-80K	FRQ + ACV + DCI
244-80N	ACA + ACV + FRQ + ETM
244-80P	3 x ACV
244-80Q	ACV // FRQ // ETM + ACA
244-80R	ACV // ETM + 2 x ACV
244-80S	2 x ACV + 2 x ACA
244-80T	FRQ // ETM + ACV
244-80U	3 x ACA + ACV
244-80W	ETM // FRQ + DCI + ACV
244-80X	4 x DCI
244-80Y	ETM // FRQ + DCI
244-80Z	ACV + ACA + FRQ // ETM
244-802	2 x ACV + ACA + ETM
244-803	ACV + FRQ + 2 x ACA
244-804	3 x ACA + DCI
244-806	3 x ACV + ACA
244-807	V, Hz, ETM + SWITCH

Product Codes

ACV	= Rectified AC voltmeter
ACA	= Rectified AC ammeter
DCA	= DC ammeter
DCI	= DC indicator
ETM	= Elapsed time meter
ETM(LCD)	= LCD elapsed time meter
FRQ	= Frequency meter
//	= In parallel with

Quadra 3-in-1 and 4-in-1

Connections

244-80H

Terminals

- 1 Volt neutral L3
- 3 Volt live L3
- 5 Frequency neutral
- 6 Volt live L2
- 7 Frequency live
- 8 Volt neutral L1
- 9 Volt live L1
- 11 Volt neutral L2

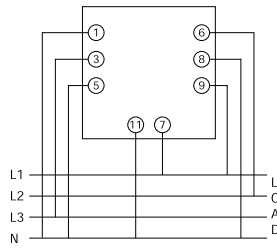

244-80I

Terminals

- 1 Neutral hours run
- 3 Live hours run
- 5 Current start red L1
- 10 Current finish black L1
- 11 Current start red L3
- 7 Current finish black L3
- 9 Current start red L2
- 8 Current finish black L2

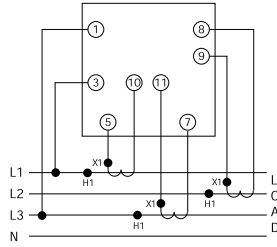
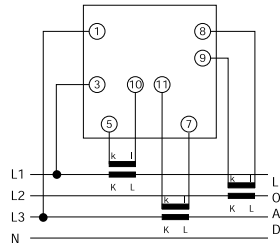

244-80J

Terminals

- 1 Current start red L1
- 3 Current finish black L1
- 2 Live hours run
- 4 Neutral hours run
- 6 Current start red L2
- 8 Current finish black L2
- 9 Current start red L3
- 7 Current finish black L3

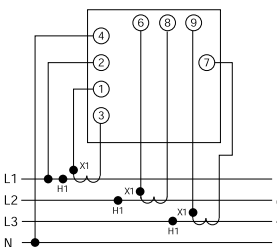
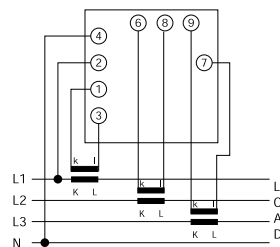

244-80Q

Terminals

- 1 Live hours run
- 5 Live volts and frequency
- 7 Neutral
- 8 Current start red
- 9 Current finish black

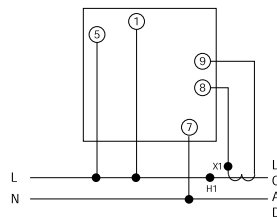
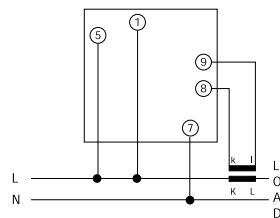

244-80T

Terminals

- 1 Voltmeter input
- 3 Voltmeter input
- 5 Hours run and frequency meter input
- 6 Hours run and frequency meter input

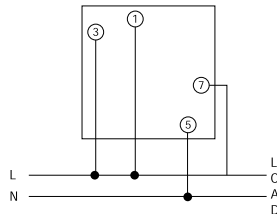

244-80X

Terminals

- 2 Positive DC 2
- 3 Positive DC 3
- 4 Negative DC 2
- 5 Negative DC 3
- 6 Positive DC 1
- 7 Positive DC 4
- 8 Negative DC 1
- 11 Negative DC 4

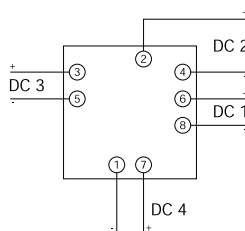

DIN Panel Meters

Moving Coil DC Ammeters and Voltmeters

Moving coil meters are suitable for all DC systems. The linear scale is calibrated down to zero and accuracy maintained down to 10%. High currents are measured with separate shunts and suitably scaled indicators. Suppressed, centre and offset-zero models are available.



Connections

DC Ammeter

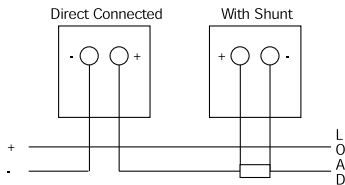

DC Voltmeter

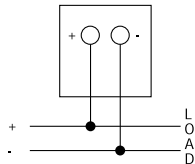

Specifications

Accuracy:	Class 1.5
Ratings:	Ammeters: 100 μ A-25A, (200 μ A for 05 model) 4/20mA suppressed zero 40A for model 243/244-01A Voltmeters: 50mV-600V 1/5V suppressed zero 50, 60, 75, 100, 150mV for use with shunts
Impedance:	Ammeters: 75mV internal shunt above 60mA Voltmeters: 1000 Ω /V above 1V

Further details available on request.

Product Codes – Long-Scale

Bezel size mm	48	72	96	144
Scale length mm	72	112	150	230
Product codes				
Ammeter	242-05A	243-05A	244-05A	246-05A
Ammeters suppressed zero	242-05R	243-05R	244-05R	246-05R
Voltmeters	242-05V	243-05V	244-05V	246-05V
Voltmeters suppressed zero	242-05S	243-05S	244-05S	246-05S

Moving Coil Dual DC Ammeters and Voltmeters

Dual instruments can be used to measure a wide range of currents and voltages, and save both space and time by requiring only one panel cut-out. The 244-80M allows for independent measurement of two DC currents in one case. The 244-80E allows for independent measurement of two DC voltages in one case.



Connections

Dual DC Ammeter

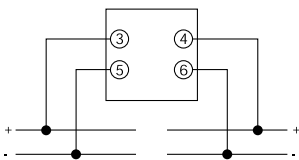

Dual DC Voltmeter

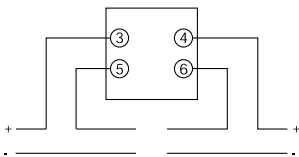

Specifications

Accuracy:	Class 1.5
Ratings:	DC Current: 100 μ A-25A direct connected 4/20mA suppressed zero. DC volts: 50mV-600V 1/5 volt suppressed zero 50, 60, 75, 150mV for use with shunts.

Product Codes – Long-Scale

Bezel size mm	96
Scale length mm	94
Product codes	
Ammeters	244-80M
Voltmeters	244-80E



DIN Panel Meters – Temperature and Process Indicators

Temperature Indicators

Long-scale indicators are used to read temperature values, usually remotely with RTD or thermocouple sensors supplied by the customer. RTD (Resistance Temperature Detector) indicators measure the change in the sensor resistance. A 2- or 3-wire system may be used. Thermocouple indicators accept standard millivolt input signals. Cold junction compensation is provided and thermocouple break indication is incorporated into the instrument.



Specifications

Accuracy:	Class 1.5 - indicator only. RTD indicator suitable for 10Ω copper 100Ω platinum, 100 and 120Ω nickel sensors. Power in RTD is around 100μW. Thermocouple indicator suitable for J (0-700°C), K (0-1200°C). 50Ω maximum circuit resistance.
Auxiliary supply:	Model 45R: from 63.5-480V AC at 50/60Hz. Model 45T: 110, 115, 220, 240, 380, 400, 480V AC and 12, 24, 48, 110, 125V DC.
Burden:	-45R 2VA, -45T 3VA

Product Codes

Bezel size mm	96	144
Scale length mm	150	230
Product codes		
RTD	244-45R	246-45R
Thermocouple	244-45T	246-45T

Process Indicators

Instruments used to check process functions both locally or remotely at centralised controls. These moving coil instruments offer a wide variety of electrical and mechanical readouts operated by transducer, tachogenerator, thermocouple, resistance bulb or other DC analogue signals. Suppressed, centre and offset zero models are available on request.

Specifications

Accuracy:	Class 1.5
Ratings:	1, 2, 5, 10 and 20mA. 4/20mA suppressed zero
Burden:	See technical data sheet T118

Product Codes – Long-Scale Models

Bezel size mm	48	72	96	144
Scale length mm	72	112	150	230
Product codes				
AC current	242-05A	243-05A	244-05A	246-05A
AC voltage	242-05V	243-05V	244-05V	246-05V
Speed	242-052	243-052	244-052	246-052
Frequency	242-053	243-053	244-053	246-053
Phase angle	242-054	243-054	244-054	246-054
Watts	242-055	243-055	244-055	246-055
VAr	242-056	243-056	244-056	246-056
VA	242-057	243-057	244-057	246-057

Connections

Thermocouple Indicators -45TG

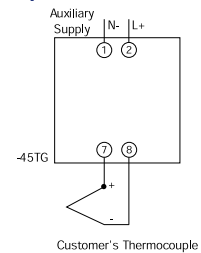

RTD Indicators -45RG

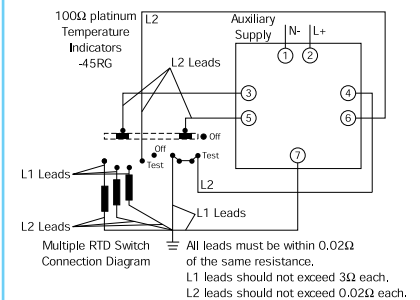

Connections

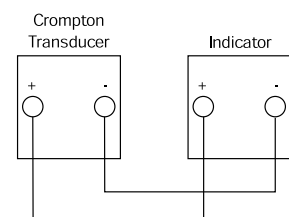

DIN Panel Meters – Tap Position and Phase Sequence



Moving Coil Tap Position Indicators

Long-scale position indicators are used to monitor transformer tap, hoist or valve positions. They employ a 3-wire system and 11 to 18 positions can be provided using 400 μ steps. The measuring system is made up of a moving coil indicator, stabilised power supply and transducer. Indicators can accept user-supplied remote potentiometer or resistance thermometer sensors.

Connections

Tap position indicator with self-contained power source

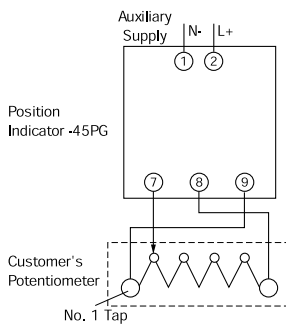

Specifications

Accuracy:	Class 1.5
Auxiliary supply:	AC 50, 110, 220, 240V, 50/60Hz DC 50, 110, 125, 220V, $\pm 15\%$
Burden:	2VA

Product Codes

Bezel size mm	96	144
Scale length mm	150	230
Product codes		
Position indicator	244-45P	246-45P

Phase Sequence Indicators

Electronic phase sequence indicators ensure correct phase rotation and the presence of all 3-phase supplies. Incorrect or loss of phase can cause serious damage in a wide range of electrical machines. Ship-to-shore supplies, mobile generators and remote installations are particularly vulnerable to this problem.



Connections

Phase Sequence Indicators

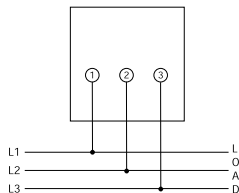

Specifications

Voltage:	151/300V, 301/500V 100/150V (Model 244-12P only)
Frequency:	50/60Hz
Burden:	2.5VA/phase

Product Codes

Bezel size mm	72	96
Product codes		
Phase sequence indicator	243-12P	244-12P

DIN Panel Meters – Phase Angle Meters

Electronic Phase Angle Meters

Phase angle meters indicate the phase displacement between current and voltage. They are used in applications where the phase angle must be monitored, for example with tariffs having VAR penalties, or to optimise generator power delivery.

The measuring system includes a moving coil indicator and a phase angle transducer. The 244 and 246 models are self contained.



Specifications

Accuracy:	Class 2.5 (2° electrical)
Ratings:	Current: 1A or 5A for CTs. Voltage: 100/130V, 200-250V and 380-450V, 100-110 for VT use.
Frequency:	50Hz, 60Hz, 400Hz.
Burden at 50Hz:	Current: 1VA Voltage: 4VA per phase
Current range:	20-125%

Product Codes – Short-Scale Models

Bezel size mm	72	96	144
Scale length mm	65	94	145
Product codes			
Single phase	E243-014-G-FA+ 256-TPS	244-42B	246-425
3-phase 3/4 wire balanced load	E243-014-G-FA+ 256-TPT	244-42A	246-42A

Product Codes – Long-Scale Models

Bezel size mm	72	96	144
Scale length mm	112	150	230
Product codes			
Single phase	243-054G-FA+ 256-TPS	244-425	246-425
3-phase 3/4 wire balanced load	–	244-427	246-427

Connections

Single Phase Systems

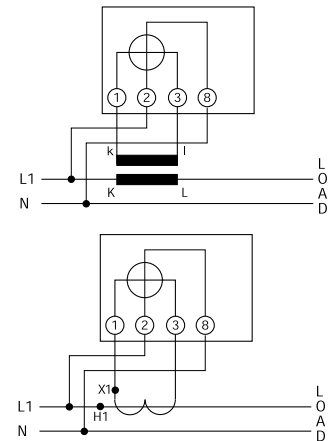

3-Phase, 3-4-Wire Balanced Systems

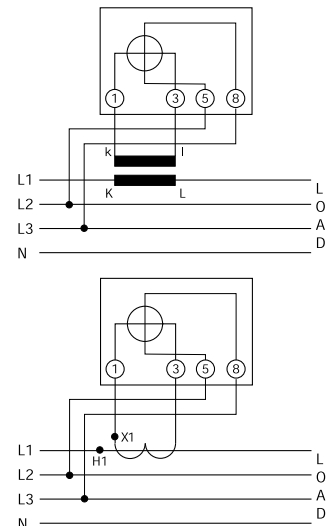



DIN Panel Meters – 360° Power Factor Indicator

360° Dynamometer Power Factor Indicators

Power factor indicators are suitable for generators or supplies operating in parallel. The four quadrant 360° scale calibrated $\cos \theta$ 0-1-0-1-0 indicates forward (export) and reverse (import) power flow for inductive and capacitive loads.

Specifications

Accuracy:	Class 2.5 (2° electrical)
Ratings:	Current: -/1A or -/5A for CTs Voltage: 60-600V, 100/110 for VT use.
Frequency:	50Hz or 60Hz
Burden:	Current: 2VA per coil @ 50Hz Voltage: 4VA per coil @ 50Hz (7.5VA > 250V)

Product Codes

Bezel size mm	96	144
Scale length	360°	360°
Product codes		
Single phase	244-137	246-137
3-phase 3- or 4-wire 3-currents + 1 voltage	244-131	246-131
3-phase 3- or 4-wire 1-current + 3 voltages	244-132	246-132
3-phase 3- or 4-wire, unbalanced load	244-136	246-136

Connections

Single Phase



3-phase 3- or 4-wire 1-current 3-voltages, balanced load

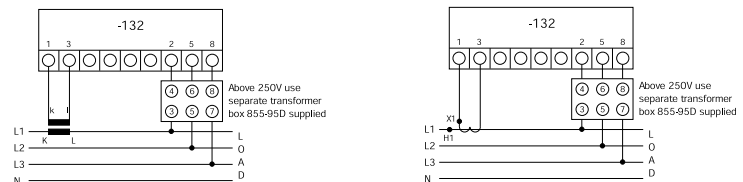

3-phase 3- or 4-wire, unbalanced load

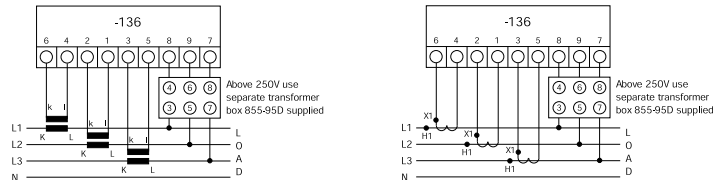

3-phase 3- or 4-wire 3-voltage, balanced load

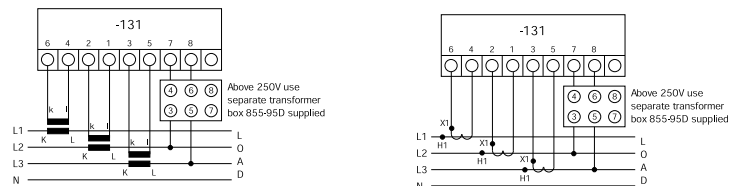

3-phase 3-wire using two CTs, unbalanced load

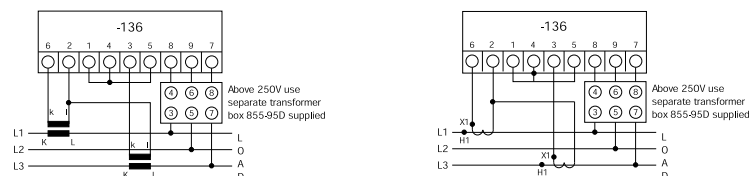

DIN Panel Meters – Synchroscope

360° Dynamometer Synchroscope

Where manual parallelling of two AC systems is necessary, the frequency of both systems can be monitored by a synchroscope. The systems are synchronised when the pointer is stationary in the 12 o'clock position. The instrument uses silicon oil damping and is rated for continuous operation and connection.



Specifications

Accuracy:	Class 2.5 (2° electrical)
Ratings voltage:	100-125V, 200-250V, 380-450V* * Use transformer box 855-954 100-110V for VT use
Frequency:	50Hz, 60Hz, 50/60Hz, 400Hz
Burden at 50Hz:	5VA maximum.

Product Codes

Bezel size mm	96	144
Scale length	360°	360°
Product codes		
50Hz	244-145	246-145
60Hz	244-146	246-146
50/60Hz	244-147	246-147
400Hz	244-144	246-144

Connections

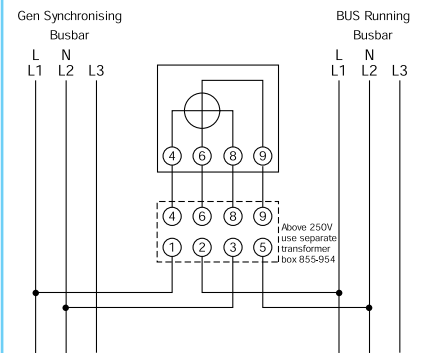

DIN Panel Meters – LED Synchroscope

360° LED Synchroscope and Synchro Check Relay

Where manual parallelling of two AC systems is desired, the frequency of both systems can be monitored by an LED synchroscope. The systems are synchronised when the green LED is lit in the 12 o'clock position. The instrument is rated for continuous operation and connection. For the semi-automatic parallelling of two AC systems, the voltage, phase displacement and the frequency of both systems can be monitored by this LED synchroscope and synchro check relay. Controls for voltage, phase angle, and time delay are provided. The systems are synchronised when the green triangular LEDs are lit together with the GEN/BUS green LEDs. A dead bus option is also available.

Connections

360° LED Synchroscope

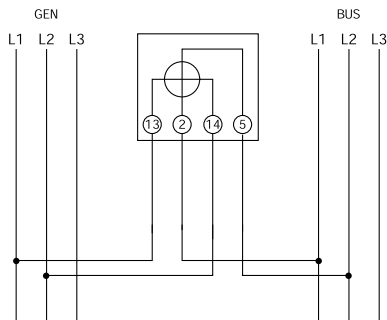

360° LED Synchroscope and Synchro Check Relay

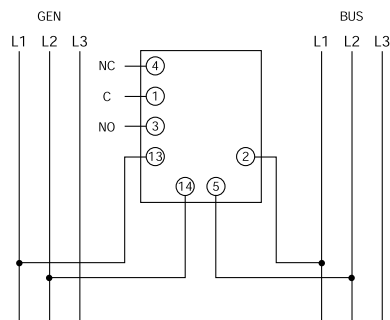

Specifications

Ratings voltage:	63.5, 110, 120, 220, 230, 240, 380, 400, 415, 440, 480V 110/120V (115V nominal) 220/240V (230V nominal) 380/480V (430V nominal) Volts AC or via VT
Frequency:	40/65Hz
Burden at 50Hz:	4VA maximum Suitable for single or three phase systems
Safety:	IEC1010-1 (300V AC RMS installation degree 2)
Dielectric:	4kV rms for 1 minute
Isolation:	BUS/GEN/RELAY
Vibration:	To Lloyds shipping specification
*Phase difference:	+0-20°, +/-1°
*Voltage difference:	+0-20%, +/-2% 0-10% for models G and H
*Time delay:	0-2.5 seconds +10%
*Accuracy:	Synchronisation at T.DC is +1°

*Only for the 360° LED synchroscope and synchro check relay.

Product Codes

Bezel size mm	96	96	96
Scale length mm	360° LED	360° LED	360° LED
3- or 4-wire	Synchroscope	Synchroscope and synchro check	Synchroscope and synchro check relay (dead bus)
40-65Hz			
Product codes			
110/120V	-	244-14GG-POBX	244-14HG-POBX
220/240V	-	244-14GG-R5BX	244-14HG-R5BX
380/480V	-	244-14GG-RUBX	244-14HG-RUBX
63.5V	244-14AG-NXYY	244-14LG-NXBX	244-14DG-NXBX
110V	244-14AG-PMYY	244-14LG-PMBX	244-14DG-PMBX
220V	244-14AG-R4YY	244-14LG-R4BX	244-14DG-R4BX
230V	244-14AG-RQYY	244-14LG-RQBX	244-14DG-RQBX
240V	244-14AG-RRYY	244-14LG-RRBX	244-14DG-RRBX
380V	244-14AG-RUYY	244-14LG-RUBX	244-14DG-RUBX
400V	244-14AG-SCYY	244-14LG-SCBX	244-14DG-SCBX
415V	244-14AG-SBYY	244-14LG-SBBX	244-14DG-SBBX
440V	244-14AG-SHY Y	244-14LG-SHBX	244-14DG-SHBX
480V	244-14AG-SEYY	244-14LG-SEBX	244-14DG-SEBX

For the 244-14L and 244-14D models, the generator voltage is compared to the nominal input (bus) voltage specified at time of ordering. For the 244-14G and 244-14H models, the generator voltage is compared to the measured bus voltage.



DIN Panel Meters – Power

Wattmeters and VArmeters

The 244/246 models are self contained and able to measure active and reactive power in both balanced and unbalanced, single and 3-phase 3- or 4-wire systems. Wattmeters are ideal for clear precise analogue indication of power in applications such as power generation, industrial control panels and power distribution.



Specifications

Accuracy:	Short-scale: Class 2.5 Long-scale: Class 1.5
Measuring ranges:	Voltage: 94-106% Current: 0-120%
Frequency influence:	0.4%Hz
Rating:	Current: 0.2-5A, direct connected 1A-5A for CTs. Voltages: 57.7-480V
Overload:	120% of nominal continuous voltage up to 600V maximum
Maximum input:	600V
Frequency:	50Hz or 60Hz
Power factor:	Unity power factor assumed range 0.5/1/0.5
Burden:	Current: 1VA per phase Voltage: 1VA per phase
Warm-up time:	<15 minutes

Product Codes – Short-Scale Models

Bezel size mm	72	96	144
Scale length mm	65	95	145
Wattmeters product code			
Single phase	E243-015-G-FA+256-TWK	244-210	246-210
3-phase 3-wire balanced load	E243-015-G-FA+256-TWL	244-211	246-211
3-phase 4-wire balanced load	E243-015-G-FA+256-TWH	244-21C	246-21C
3-phase 3-wire unbalanced load	E243-015-G-FA+256-TWM	244-213	246-213
3-phase 4-wire unbal. star CT	E243-015-G-FA+256-TWN	244-214	246-214
3-phase 4-wire unbal. delta CT	E243-015-G-FA+256-TWJ	244-21E	246-21E
3-phase 4-wire 3-element	E243-015-G-FA+256-XWW	244-21Y	246-21Y
VArmeters product codes			
3-phase 3- or 4-wire balanced load	E243-016-G-FA+256-TXG	244-310	246-310
3-phase 3-wire unbalanced load	E243-016-G-FA+256-TXM	244-31S	246-31S
3-phase 4-wire unbal. star CT	E243-016-G-FA+256-TXN	244-314	246-314
3-phase 4-wire unbal. delta CT	E243-016-G-FA+256-TXJ	244-31E	246-31E

Product Codes – Long-Scale Models

Bezel size mm	72	96	144
Scale length mm	112	150	230
Wattmeters product code			
Single phase	243-055G-FA+256-TWK	244-215	246-215
3-phase 3-wire balanced load	243-055G-FA+256-TWL	244-216	246-216
3-phase 4-wire balanced load	243-055G-FA+256-TWH	244-21D	246-21D
3-phase 3-wire unbalanced load	243-055G-FA+256-TWM	244-218	246-218
3-phase 4-wire unbal. star CT	243-055G-FA+256-TWN	244-219	246-219
3-phase 4-wire unbal. delta CT	243-055G-FA+256-TWJ	244-21F	246-21F
3-phase 4-wire 3-element	243-055G-FA+256-XWW	244-21Z	246-21Z
VArmeters product codes			
3-phase 3- or 4-wire balanced load	243-056G-FA+256-TXG	244-315	246-315
3-phase 3-wire unbalanced load	243-056G-FA+256-TXM	244-31L	246-31L
3-phase 4-wire unbal. star CT	243-056G-FA+256-TXN	244-319	246-319
3-phase 4-wire unbal. delta CT	243-056G-FA+256-TXJ	244-31F	246-31F

Models E243-015, E243-016, E243-055 and E243-056 use a separate transducer. Crompton transducers are ideal for this application. Our product code reference assumes a 1mA output. Other outputs of 5, 10, 20 or 4/20mA can also be used.



DIN Panel Meters – Power

Wattmeter Connection Diagrams

Single Phase

224-210, 244-215, 246-210, 246-215

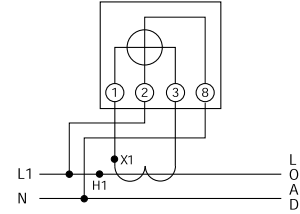
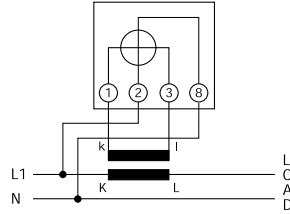

3-phase 4-wire balanced load

244-21C, 246-21C, 244-21D, 246-21D

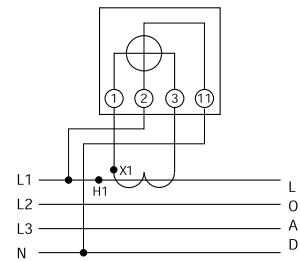
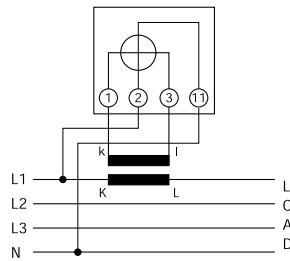

3-phase 3-wire balanced load

244-211, 246-211, 244-216, 246-216

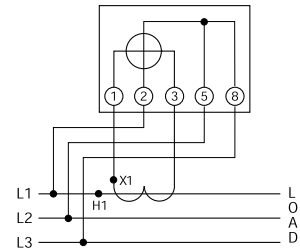
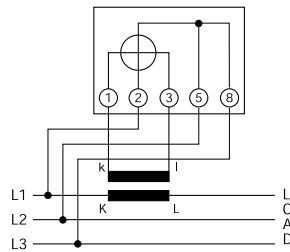

3-phase 3-wire unbalanced load 2-element

244-213, 246-213, 244-218, 246-218

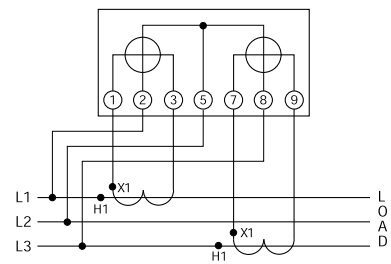
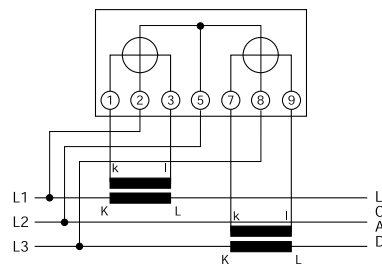

Wattmeter Connection Diagrams

3-phase 4-wire unbalanced load star connected CTs 2¹/₂-element
 244-214, 246-214, 244-219, 246-219

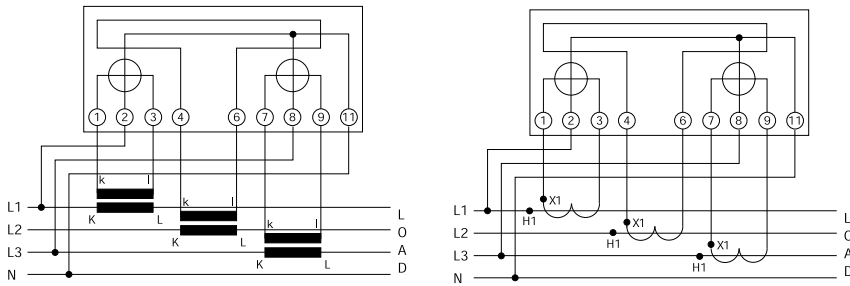

3-phase 4-wire unbalanced load delta connected CTs
 244-21E, 246-21E, 244-21F, 246-21F

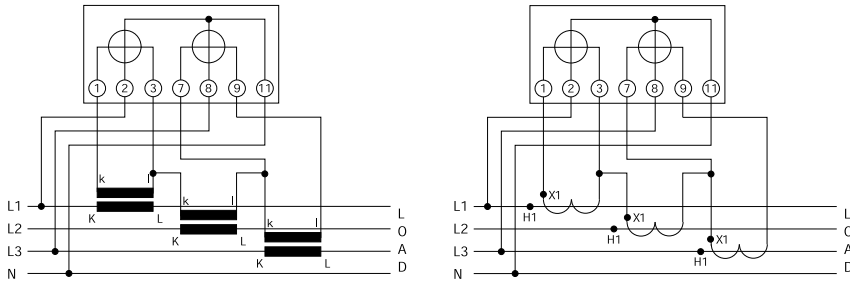

3-phase 4-wire unbalanced load star connected CTs 3-element
 244-21Y, 246-21Y, 244-21Z, 246-21Z

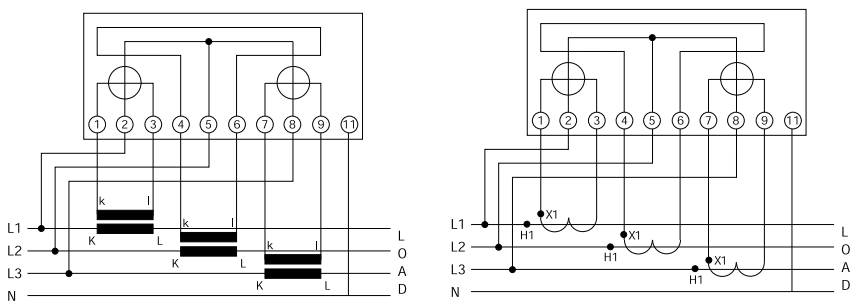

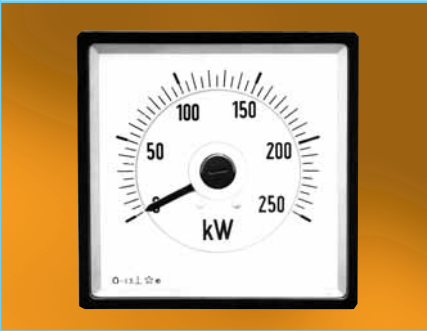

DIN Panel Meters – Power

VArmeter Connection Diagrams

3-Phase 3- or 4-Wire Balanced Load, 1-Element
 244-310, 246-310, 244-315, 246-315

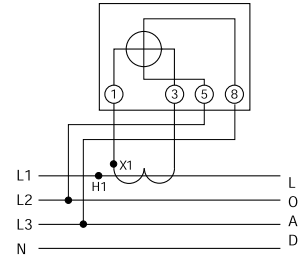
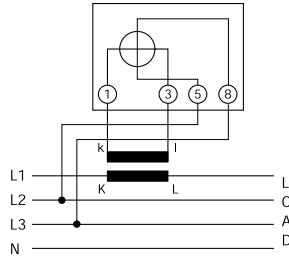

3-Phase 4-Wire Unbalanced Star Connected CTs, 2 1/2-Element
 244-314, 246-314, 244-319, 246-319

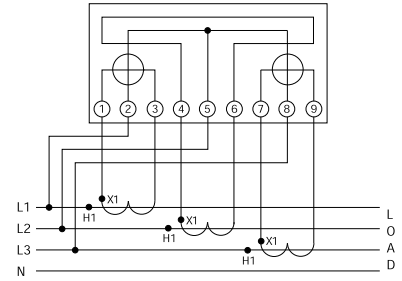
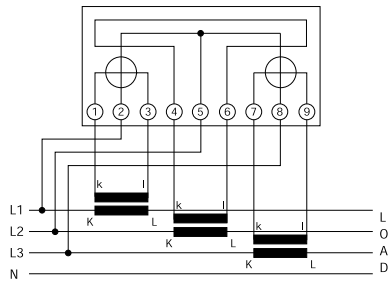

3-Phase 3-Wire Unbalanced Load, 2-Element
 244-31S, 246-31S, 244-31L, 246-31L

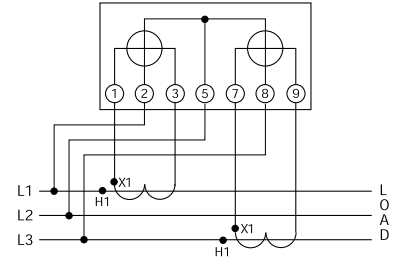
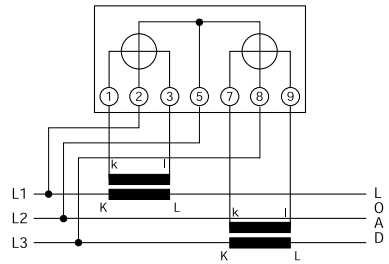

3-Phase 4-Wire Unbalanced Delta Connected CTs, 2 1/2-Element
 244-31E, 246-31E, 244-31F, 246-31F

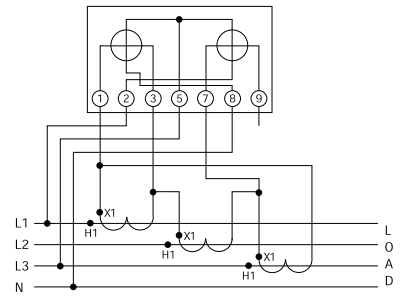
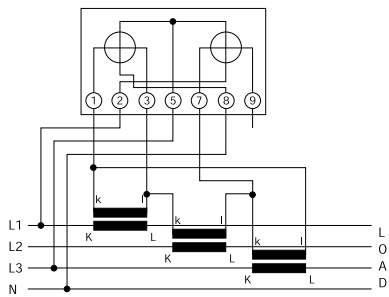

Instrument Selector Switches

Panel mounted selector switches offer a 7-position voltmeter switch and a 4-position ammeter switch for reading line-to-line or line-to-neutral voltage and phase current. Each switch can be supplied with either numbered or coloured annotation.

Specifications

Loading capacity:	SO1 and SO2: 20A, 500V. SO3: 12A/480V
Switching capacity:	3kW at 220V, 5kW at 380V, 5.5kW at 500V
Isolating voltage:	SO1 and SO2: 500V AC. SO3: 480V AC
Operating temperature:	-20°C to + 70°C
Mounting installation:	Two point front fixing
Dimensions:	48mm x 48mm
Panel cut out:	3 drilled holes
Compliant with:	LVD and EMC
IP protection:	SO1 and SO2: IP65. SO3: IP54

Product Codes

SO1 Three hole fixing 20A	
SO1-SAB	4-position ammeter switch, L1-L2-L3-0
SO1-SAA	4-position ammeter switch, R-Y-B-O
SO1-SVE	7-position voltmeter switch, RY-YB-RB-0-RN-YN-BN
SO1-SVD	7-position voltmeter switch, L1L2-L2L3-L3L1-0-L1N-L2N-L3N
SO2 Single hole mount 20A	
SO2-SAB	4-position ammeter switch, L1-L2-L3-0
SO2-SAA	4-position ammeter switch, R-Y-B-O
SO2-SVE	7-position voltmeter switch, RY-YB-RB-0-RN-YN-BN
SO2-SVD	7-position voltmeter switch, L1L2-L2L3-L3L1-0-L1N-L2N-L3N
SO3 Three hole fixing 12A	
SO3-SAB	4-position ammeter switch, L1-L2-L3-0
SO3-SVD	7-position voltmeter switch, L1L2-L2L3-L3L1-0-L1N-L2N-L3N

Dimensions

SO1 Three Hole Fixing 20 Amp

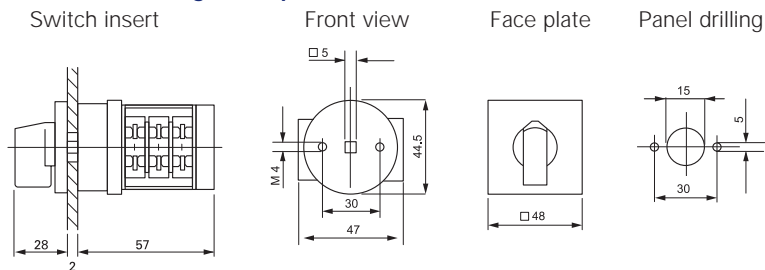

SO2 Single Hole Fixing 20 Amp

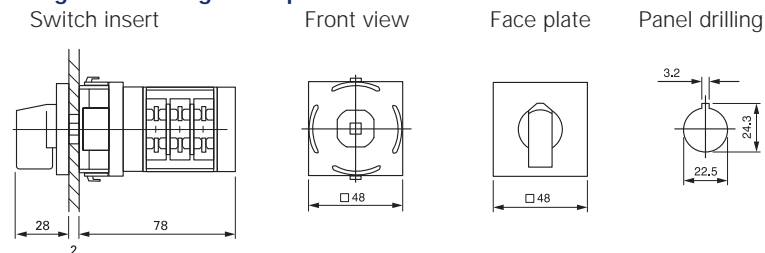

SO3 Three Hole Fixing 12 Amp

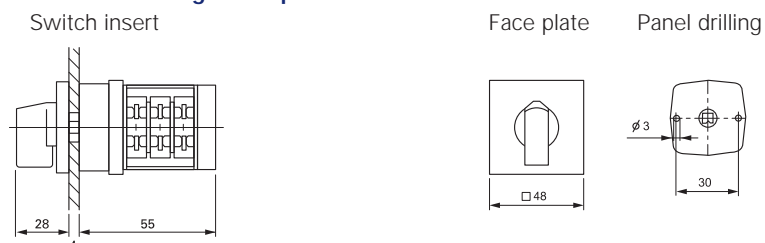

Connections

Voltmeter Change-over Switches

For measuring 3-interconnected voltages and 3-phase voltage against N.

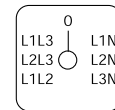

SO1 and SO2

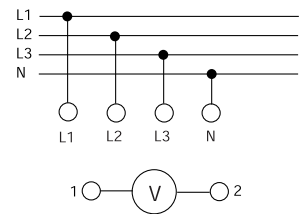

SO3



Ammeter-Change-over Switches

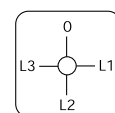

SO1 and SO2

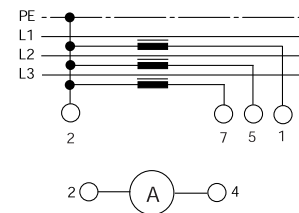

SO3

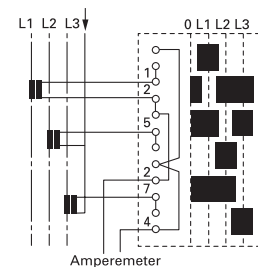



070 Series ANSI Switchboard Meters

High quality range of switchboard instruments with Class 1 accuracy and which complies with American ANSI-C39.1 (1981) specifications. Available in 4 1/2" and 8 3/4" case sizes, their rugged design characteristics meet the needs of the most demanding environmental applications. This extensive range of analogue and digital/analogue meters utilises high shock oil dampened movements and provides 1% accuracy for all RMS AC and DC ranges. The range offers various customised options and features.

Features

Rugged Hi-Q taut band suspension
Class 1 accuracy
JIS dimensioned product available on request

Benefits

Meets all the requirements of ANSI-C39.1 (1981)
Parallax error-free platform dials
Bump, shock and vibration proof
Customised options and features

Applications

Switchgear
Distribution systems
Generator sets
Control panels
Energy management
Building management
Utility power monitoring
Process control
Motor control

Approvals

UL approved file no. E203000
ABS (American Bureau of Shipping)
93-LD 17806-X

Description

070 series offers two case sizes, 4 1/2" (Models 075, 077 and 078) and 8 3/4" (Model 079). Model 078 is high shock hermetically sealed and all models have heavy gauge pressed steel cases. Mounting is by four integral studs.

Models 075 and 077 are a one piece flame retardant polycarbonate moulding with a black matte finished bezel area, and a specially contoured window to minimise reflection from adjacent light sources. Model 079 has a black pressed steel bezel with a toughened glass window, and Model 078 has a die-cast bezel and a projecting moulded toughened glass window, which incorporates a gas tight zero adjuster.

Scales are 240° moving iron and 250° moving coil with parallax error-free platform dials. Standard dials are white matte with black printed scales and bar knife-edge pointers. Black dials with white or yellow scales and pointers are also available.

General options include supplementary red pointer (075 and 077), slave pointer, calibration for non standard ambient temperatures, special scales, trim potentiometers, and illuminated dials with white or red light sources.

Specifications

Performance:	ANSI C39.1 (1981)
Accuracy:	Class 1
Terminals:	10-32 UNF terminals (M5 screw clamp terminal for Model 075)
Dielectric voltage:	Withstand test 2.3kV for 1 minute
Response time:	Approximately 2.5 seconds to full scale (077 and 078) and 3.5 seconds (079)
Overshoot:	33% maximum
Standard calibration:	23°C
Operating temperature:	0°C to +40°C. Model 078: -40°C to +70°C.
Storage temperature:	-10°C to +50°C
Extreme temp range:	-20°C to +65°C
Enclosure integrity:	Models 075/077/079 to IP54(NEMA 3S) splash proof, IP55 (NEMA 4) hoseproof is an optional extra Model 078 to IP67 (NEMA 6 and 6P)
Fixing on panel:	4 integral 1/4"-28 UNF fixing studs
Approvals:	EMC and LVD, UL and ABS

Dimensions

Model	Panel cut-out			Rear view				
	Dia	A	B	C	D	E	F	G
075	103	86	43	110	17	-	30	101
077	103	86	43	110	17	-	30	101
078	103	86	43	110	17	-	30	101
079	229	86	43	229	17	-	30	101

Dimension E varies with measured parameter - see product code table overleaf.

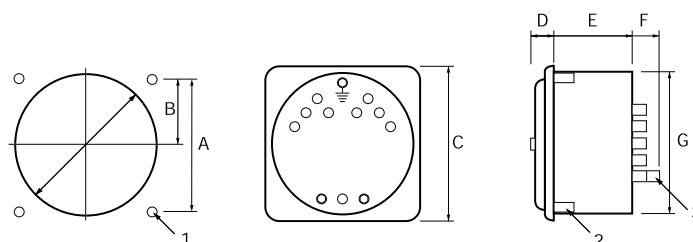

1 - 4 Fixing holes Ø 8mm. 2 - 1/4-28 UNF fixing studs. 3 - 10-32 UNF Terminals (M5 screw clamp terminal on model 075).



Product Codes

Type of instrument	Ranges	Case codes				Product codes
		075	077	078	079	
AC ammeter moving iron	0.5-10A	56	56	-	-	075/077-08A
AC ammeter moving iron	0.5-10A	-	-	86	86	078/079-08A
AC ammeter moving iron	10.1-30A	-	86	86	86	077/078/079-08A
Slave pointer ammeter	1 or 5A		86			077-08D
6 x overload AC ammeter	5/30A - 30/180A	-	86	86	86	077/078/079-086
AC voltmeter moving iron	30-800V	-	86	86	86	077/078/079-08V
AC rectified ammeter	1-30A	56	56	86	56	075/077/078/079-05B
AC rectified voltmeter	30-800V	56	56	86	56	075/077/078/079-05W
AC voltmeter expanded scale	110-130V	-	86	86	86	077/078/079-05Y
AC RMS ammeter	1-30A	56	56	86	56	075/077/078/079-05F
AC RMS voltmeter	150-750V	56	56	86	56	075/077/078/079-05G
Slave pointer voltmeter	50-300V		86			077-05X
Elapsed time meter (99999.99)	50 or 60Hz / 100-440V* and DC	-	56	56	-	077/078-155/156/077-151
Frequency meter	50, 60 400Hz/100-440V**	86	86	86	86	075/077/078/079-41L
AC wattmeter or VArmeter	0.2-10A/100-440V*	-	132	132	132	077/078/079-21 or 31
360° rotary power factor meter	0.2-10A/100-600V	-	132	132	132	077/078/079-13
360° rotary synchroscope	100/125V, 200/250, 380/450***	-	132	132	132	077/078/079-14
LED synchroscope only	63.5-480V****	-	86	-	-	077-14A
LED synchroscope and synchro check relay	63.5-480V****	-	86	-	-	077-14
AC meter relay	AC6V-500V, 100µA-1A, 5A via CT	-	86	-	-	077-30 (see Meter Relay section)
Phase sequence indicator	100-150, 151-300, 301-500V	-	56	-	-	077-12P
Maximum demand Indicator	1 or 5A	-	86	-	-	077-16
Tap position indicator	1-18 steps. 400Ω	-	86	-	-	077-45P
Transducer operated indicator	1, 5, 10, 20, or 4/20mA	56	56	56	56	075/077/078/079-05
DC ammeter moving coil	200µA - 30A 56	56	56	56		075/077/078/079-05A
DC voltmeter moving coil	50mV-600V 56	56	56	56		075/077/078/079-05V
DC meter relay	100mV-500V, 10µA-15A	-	86	-	-	077-30 (see Meter Relay section)
Temperature indicator	RTD	-	86	86	86	077/078/079-45R
Temperature indicator	Thermocouple	-	86	86	86	077/078/079-45T
240° phase angle /power factor	1 or 5A, 100-400V 50, 60 or 400Hz	-	132	132	132	077/078/079-42
Watt/hour indicators:						
Watt/hour indicator	1 or 5A / 69-277V****	-	132	-	-	077-KH
Transducer operated	1, 5, 10, 20, or 4/20mA	-	132	132	-	077-KH
Analogue/LED digital indicators						
AC ammeter	1mA - 10A	-	86	-	-	077-DIB
AC voltmeter	200mV - 600V	-	86	-	-	077-DIW
AC wattmeter	69V/5A, 120V/5A, 50 or 60Hz	-	86	-	-	077-DW
AC VArmeter	120V/5A, 208V/5A, 50 or 60Hz	-	86	-	-	077-DX
Phase angle meter	69V/5A, 120V/5A, 50 or 60Hz	-	86	-	-	077-DP
Frequency meter	110/130V, 50 or 60Hz	-	86	-	-	077-DZ
DC ammeter	1mA - 1A	-	86	-	-	077-DIA
DC voltmeter	20mV - 600V	-	86	-	-	077-DIV
Transducer indicator	DC mA	-	86	-	-	077-DIT
Tachometer	AC or DC rated	-	86	-	-	077-DI2

* 100-440V = (100/125, 200/250, 380/440)

** 100-440V = (100/125, 200/250, 380/440). Frequencies 45/55, 55/65, 45/65, 47/53, 57/63, 360/440.

*** Using transformer box 855-954

**** Nominal voltage to be specified

For specification and connection diagrams, please refer to equivalent models in 240 Series DIN Panel Meter section. Replace 244 with 077 etc., e.g. 244-210 becomes 077-210.



AC and DC Ammeters, Voltmeters and Frequency Meters

This range of self contained, Hi-Q, taut band moving coil meters feature 250° linear scale and oil dampened mechanisms for superior performance in high vibration situations. AC instruments are available with true RMS converting circuit or RMS compensated rectifier. While types of frequency meters can be damaged by transient supply voltage spike. Crompton 077-41 frequency meters can withstand, without damage, 10 successive transient spikes of 1250 volts. The range offers UL and CSA approvals. JIS dimensioned products are available on request.

Specifications – General

Manufactured in accordance with American National Standards ANSI C39.1, (1981)

Accuracy:	±1% full scale at 23°C (73°F)
Scale arc:	250° full scale deflection
Scale length:	077 and 078: 175.2 mm (6.9") 079: 353 mm (13.9")
Scale plate:	2 piece, platform type
Response time:	077 and 078: Approximately 2.5 seconds to full scale 079: Approximately 3.5 seconds to full scale
Operating temperature:	0 to 40°C (32 to 104°F)
Storage temperature:	-10 to +50°C (14 to 122°F)
Extreme temp range:	-20° to +65°C (-4° to 149°F)
Terminals:	Standard 10-32 UNF stud. M5 screw clamp is optional.
Position:	Vertical (scale)
Dielectric withstand:	2300V AC for 1 minute between electrical circuit and case
Overshoot:	33% maximum
Enclosure code:	077 and 079: IP54, optional IP55 078: IP67
Approvals:	EMC and LVD. UL approved file no. E203000

Specifications – Ammeters and Voltmeters

Overload rating:	AC ammeters - 2 x continuous, 50 x for 1 second AC voltmeters and frequency meters - 1.2 x continuous DC ammeters - 2 x continuous 10 x for 1 second DC voltmeters - 1.2 x continuous
Frequency range:	AC calibration 60Hz ±20%

Specifications – Frequency Meters

Response time:	3 seconds maximum
External temperature influence:	0.6 times accuracy maximum with ±10°C from reference temperature
External field influence:	2.0 times accuracy maximum with 0.5mT field
Acceptable input harmonic content:	Up to 30% distortion

Maximum frequency Hz	Center scale Hz	Error in Hz
45-55	50	0.15
46-54	50	0.15
45-65	55	0.25
50-70	60	0.25
55-65	60	0.15
56-64	60	0.15
58-62	60	0.08
350-450	400	1.30
360-440	400	1.25
380-420	400	0.80

Moving Iron AC Ammeters

Product Codes – Self Contained 40/70Hz (Accuracy $\pm 1\%$, 60Hz)***

Rating	Scaling*	4 1/2" square flange		8 3/4" square flange
		Standard case catalogue no.	Sealed case hi-shock catalogue no.	Standard case catalogue no.
1A0-1A		•/+077-08AA-LALA-C6	078-08AJ-LALA-C6	•079-08AA-LALA-C6
1.5A	0-1.5A	•/+077-08AA-LCLC-C6	078-08AJ-LCLC-C6	•079-08AA-LCLC-C6
2A0-2A		•/+077-08AA-LELE-C6	078-08AJ-LELE-C6	•079-08AA-LELE-C6
3A0-3A		•/+077-08AA-LJLJ-C6	078-08AJ-LJLJ-C6	•079-08AA-LJLJ-C6
5A0-5A		•/+077-08AA-LSLS-C6	078-08AJ-LSLS-C6	•079-08AA-LSLS-C6
7.5A	0-7.5A	•/+077-08AA-MFMF-C6	078-08AJ-MFMF-C6	•079-08AA-MFMF-C6
10A	0-10A	•/+077-08AA-MTMT-C6	078-08AJ-MTMT-C6	•079-08AA-MTMT-C6
15A	0-15A	•/+077-08AA-NDND-C6	078-08AJ-NDND-C6	•079-08AA-NDND-C6
20A	0-20A	•/+077-08AA-NGNG-C6	078-08AJ-NGNG-C6	•079-08AA-NGNG-C6
30A	0-30A	•/+077-08AA-NLNL-C6	078-08AJ-NLNL-C6	•079-08AA-NLNL-C6



AC Overload Ammeters

Product Codes – Transformer Rated 40/70Hz - Burden 0.3VA***

5A	0-10A	•/+077-08AA-LSMT-C6	078-08AJ-LSMT-C6	•079-08AA-LSMT-C6
5A	0-15A	•/+077-08AA-LSND-C6	078-08AJ-LSND-C6	•079-08AA-LSND-C6
5A	0-20A	•/+077-08AA-LSNG-C6	078-08AJ-LSNG-C6	•079-08AA-LSNG-C6
5A	0-25A	•/+077-08AA-LSNJ-C6	078-08AJ-LSNJ-C6	•079-08AA-LSNJ-C6
5A	0-30A	•/+077-08AA-LSNL-C6	078-08AJ-LSNL-C6	•079-08AA-LSNL-C6
5A	0-40A	•/+077-08AA-LSNP-C6	078-08AJ-LSNP-C6	•079-08AA-LSNP-C6
5A	0-50A	•/+077-08AA-LSNT-C6	078-08AJ-LSNT-C6	•079-08AA-LSNT-C6
5A	0-75A	•/+077-08AA-LSPB-C6	078-08AJ-LSPB-C6	•079-08AA-LSPB-C6
5A	0-100A	•/+077-08AA-LSPK-C6	078-08AJ-LSPK-C6	•079-08AA-LSPK-C6
5A	0-150A	•/+077-08AA-LSPZ-C6	078-08AJ-LSPZ-C6	•079-08AA-LSPZ-C6
5A	0-200A	•/+077-08AA-LSRL-C6	078-08AJ-LSRL-C6	•079-08AA-LSRL-C6
5A	0-250A	•/+077-08AA-LSRS-C6	078-08AJ-LSRS-C6	•079-08AA-LSRS-C6
5A	0-300A	•/+077-08AA-LSRX-C6	078-08AJ-LSRX-C6	•079-08AA-LSRX-C6
5A	0-400A	•/+077-08AA-LSSC-C6	078-08AJ-LSSC-C6	•079-08AA-LSSC-C6
5A	0-500A	•/+077-08AA-LSSF-C6	078-08AJ-LSSF-C6	•079-08AA-LSSF-C6
5A	0-600A	•/+077-08AA-LSSJ-C6	078-08AJ-LSSJ-C6	•079-08AA-LSSJ-C6
5A	0-800A	•/+077-08AA-LSSN-C6	078-08AJ-LSSN-C6	•079-08AA-LSSN-C6
5A	0-1000A	•/+077-08AA-LSSS-C6	078-08AJ-LSSS-C6	•079-08AA-LSSS-C6
5A	0-1200A	•/+077-08AA-LSSU-C6	078-08AJ-LSSU-C6	•079-08AA-LSSU-C6
5A	0-1500A	•/+077-08AA-LSTC-C6	078-08AJ-LSTC-C6	•079-08AA-LSTC-C6
5A	0-1600A	•/+077-08AA-LSTE-C6	078-08AJ-LSTE-C6	•079-08AA-LSTE-C6
5A	0-2000A	•/+077-08AA-LSTM-C6	078-08AJ-LSTM-C6	•079-08AA-LSTM-C6
5A	0-2500A	•/+077-08AA-LSTU-C6	078-08AJ-LSTU-C6	•079-08AA-LSTU-C6
5A	0-3000A	•/+077-08AA-LSUA-C6	078-08AJ-LSUA-C6	•079-08AA-LSUA-C6
5A	0-4000A	•/+077-08AA-LSUE-C6	078-08AJ-LSUE-C6	•079-08AA-LSUE-C6
5A	0-5000A	•/+077-08AA-LSUJ-C6	078-08AJ-LSUJ-C6	•079-08AA-LSUJ-C6
5A	0-6000A	•/+077-08AA-LSUP-C6	078-08AJ-LSUP-C6	•079-08AA-LSUP-C6
5A	0-7000A	•/+077-08AA-LSUS-C6	078-08AJ-LSUS-C6	•079-08AA-LSUS-C6
5A	0-8000A	•/+077-08AA-LSUW-C6	078-08AJ-LSUW-C6	•079-08AA-LSUW-C6

Product Code – AC Overload Ammeters - True RMS Reading***
Self Contained 40/70Hz (Accuracy $\pm 1\%$)

5/30A	To suit	077-086A-LS**-C6	078-086J-LS**-C6	079-086A-LS**-C6
-------	---------	------------------	------------------	------------------

077 moving iron ammeters available as listed above.

Rated 5A for standard CTs with 6 x full scale.
Overload portion of the scale is not subject to the accuracy guarantee.
• UL approved file no. E203000

* Other scales are available
** Specify scale required
*** For case types 077/078/079 use 10-32 UNF terminals. For M5 screw clamp terminals, use case type 075



AC Voltmeter

Moving Iron AC Voltmeters

Product Codes – Self Contained 60Hz $\pm 20\%$ (Accuracy $\pm 1\%$)***

Rating	Scaling*	4 1/2" square flange		8 3/4" square flange
		Standard case catalogue no.	Sealed case hi-shock catalogue no.	Standard case catalogue no.
150V	0-150V	•/+077-08VA-PZPZ-C6	078-08VJ-PZPZ-C6	•079-08VA-PZPZ-C6
250V	0-250V	•/+077-08VA-RSRS-C6	078-08VJ-RSRS-C6	•079-08VA-RSRS-C6
300V	0-300V	•/+077-08VA-RXRXC6	078-08VJ-RXRXC6	•079-08VA-RXRXC6
500V	0-500V	•/+077-08VA-SFSF-C6	078-08VJ-SFSF-C6	•079-08VA-SFSF-C6
600V	0-600V	•/+077-08VA-SJSJ-C6	078-08VJ-SJSJ-C6	•079-08VA-SJSJ-C6
750V	0-750V	077-08VA-SMSM-C6	078-08VJ-SMSM-C6	079-08VA-SMSM-C6

Product Codes – Transformer Rated 50/60HZ (Accuracy $\pm 1\%$)
0.8VA @150V***

150V	0-300V	•/+077-08VA-PZRX-C6	078-08VJ-PZRX-C6	•079-08VA-PZRX-C6
150V	0-600V	•/+077-08VA-PZSJ-C6	078-08VJ-PZSJ-C6	•079-08VA-PZSJ-C6
150V	0-750V	•/+077-08VA-PZSM-C6	078-08VJ-PZSM-C6	•079-08VA-PZSM-C6
150V	0-3000V	•/+077-08VA-PZUA-C6	078-08VJ-PZUA-C6	•079-08VA-PZUA-C6
150V	0-5250V	•/+077-08VA-PZUL-C6	078-08VJ-PZUL-C6	•079-08VA-PZUL-C6
150V	0-6000V	•/+077-08VA-PZUP-C6	078-08VJ-PZUP-C6	•079-08VA-PZUP-C6
150V	0-9000V	•/+077-08VA-PZUY-C6	078-08VJ-PZUY-C6	•079-08VA-PZUY-C6
150V	0-15KV	•/+077-08VA-PZWC-C6	078-08VJ-PZWC-C6	•079-08VA-PZWC-C6
150V	0-18KV	•/+077-08VA-PZWD-C6	078-08VJ-PZWD-C6	•079-08VA-PZWD-C6
150V	0-45KV	•/+077-08VA-PZWJ-C6	078-08VJ-PZWJ-C6	•079-08VA-PZWJ-C6
250V	0-600V	•/+077-08VA-RSSJ-C6	078-08VJ-RSSJ-C6	•079-08VA-RSSJ-C6

• UL approved file no. E203000

* Other scales are available

*** For case types 077/078/079 use 10-32 UNF terminals. For M5 screw clamp terminals, use case type 075

RMS Reading AC Ammeters

Product Codes – Self Contained 40/70Hz (Accuracy ±1%, 60Hz)***

Rating	Scaling*	4 1/2" square flange		8 3/4" square flange
		Standard case catalogue no.	Sealed case hi-shock catalogue no.	Standard case catalogue no.
1A0-1A		•/+077-05FA-LALA-C6	078-05FJ-LALA-C6	•079-05FA-LALA-C6
1.5A	0-1.5A	•/+077-05FA-LCLC-C6	078-05FJ-LCLC-C6	•079-05FA-LCLC-C6
2A	0-2A	•/+077-05FA-LELE-C6	078-05FJ-LELE-C6	•079-05FA-LELE-C6
3A	0-3A	•/+077-05FA-LJLJ-C6	078-05FJ-LJLJ-C6	•079-05FA-LJLJ-C6
5A	0-5A	•/+077-05FA-LSLS-C6	078-05FJ-LSLS-C6	•079-05FA-LSLS-C6
7.5A	0-7.5A	•/+077-05FA-MFMF-C6	078-05FJ-MFMF-C6	•079-05FA-MFMF-C6
10A	0-10A	•/+077-05FA-MTMT-C6	078-05FJ-MTMT-C6	•079-05FA-MTMT-C6
15A	0-15A	•/+077-05FA-NDND-C6	078-05FJ-NDND-C6	•079-05FA-NDND-C6
20A	0-20A	•/+077-05FA-NGNG-C6	078-05FJ-NGNG-C6	•079-05FA-NGNG-C6
30A	0-30A	•/+077-05FA-NLNL-C6	078-05FJ-NLNL-C6	•079-05FA-NLNL-C6

For AC rectified non-RMS compensated meter, please replace the -05F in the product code with -05B.

Product Codes – Transformer Rated 40/70Hz - Burden 0.3VA***

150V	0-300V	•/+077-08VA-PZRX-C6	078-08VJ-PZRX-C6	•079-08VA-PZRX-C6
5A	0-10A	•/+077-05FA-LSMT-C6	078-05FJ-LSMT-C6	•079-05FA-LSMT-C6
5A	0-15A	•/+077-05FA-LSND-C6	078-05FJ-LSND-C6	•079-05FA-LSND-C6
5A	0-20A	•/+077-05FA-LSNG-C6	078-05FJ-LSNG-C6	•079-05FA-LSNG-C6
5A	0-25A	•/+077-05FA-LSNJ-C6	078-05FJ-LSNJ-C6	•079-05FA-LSNJ-C6
5A	0-30A	•/+077-05FA-LSNL-C6	078-05FJ-LSNL-C6	•079-05FA-LSNL-C6
5A	0-40A	•/+077-05FA-LSNP-C6	078-05FJ-LSNP-C6	•079-05FA-LSNP-C6
5A	0-50A	•/+077-05FA-LSNT-C6	078-05FJ-LSNT-C6	•079-05FA-LSNT-C6
5A	0-75A	•/+077-05FA-LSPB-C6	078-05FJ-LSPB-C6	•079-05FA-LSPB-C6
5A	0-100A	•/+077-05FA-LSPK-C6	078-05FJ-LSPK-C6	•079-05FA-LSPK-C6
5A	0-150A	•/+077-05FA-LSPZ-C6	078-05FJ-LSPZ-C6	•079-05FA-LSPZ-C6
5A	0-200A	•/+077-05FA-LSRL-C6	078-05FJ-LSRL-C6	•079-05FA-LSRL-C6
5A	0-250A	•/+077-05FA-LSRS-C6	078-05FJ-LSRS-C6	•079-05FA-LSRS-C6
5A	0-300A	•/+077-05FA-LSRX-C6	078-05FJ-LSRX-C6	•079-05FA-LSRX-C6
5A	0-400A	•/+077-05FA-LSSC-C6	078-05FJ-LSSC-C6	•079-05FA-LSSC-C6
5A	0-500A	•/+077-05FA-LSSF-C6	078-05FJ-LSSF-C6	•079-05FA-LSSF-C6
5A	0-600A	•/+077-05FA-LSSJ-C6	078-05FJ-LSSJ-C6	•079-05FA-LSSJ-C6
5A	0-800A	•/+077-05FA-LSSN-C6	078-05FJ-LSSN-C6	•079-05FA-LSSN-C6
5A	0-1000A	•/+077-05FA-LSSS-C6	078-05FJ-LSSS-C6	•079-05FA-LSSS-C6
5A	0-1200A	•/+077-05FA-LSSU-C6	078-05FJ-LSSU-C6	•079-05FA-LSSU-C6
5A	0-1500A	•/+077-05FA-LSTC-C6	078-05FJ-LSTC-C6	•079-05FA-LSTC-C6
5A	0-1600A	•/+077-05FA-LSTE-C6	078-05FJ-LSTE-C6	•079-05FA-LSTE-C6
5A	0-2000A	•/+077-05FA-LSTM-C6	078-05FJ-LSTM-C6	•079-05FA-LSTM-C6
5A	0-2500A	•/+077-05FA-LSTU-C6	078-05FJ-LSTU-C6	•079-05FA-LSTU-C6
5A	0-3000A	•/+077-05FA-LSUA-C6	078-05FJ-LSUA-C6	•079-05FA-LSUA-C6
5A	0-4000A	•/+077-05FA-LSUE-C6	078-05FJ-LSUE-C6	•079-05FA-LSUE-C6
5A	0-5000A	•/+077-05FA-LSUJ-C6	078-05FJ-LSUJ-C6	•079-05FA-LSUJ-C6
5A	0-6000A	•/+077-05FA-LSUP-C6	078-05FJ-LSUP-C6	•079-05FA-LSUP-C6
5A	0-7000A	•/+077-05FA-LSUS-C6	078-05FJ-LSUS-C6	•079-05FA-LSUS-C6
5A	0-8000A	•/+077-05FA-LSUW-C6	078-05FJ-LSUW-C6	•079-05FA-LSUW-C6

For AC rectified non-RMS compensated meter, please replace the -05F in the product code with -05B.

Rated 5A for standard CT's with 6 x full scale.
Overload portion of the scale is not subject to the accuracy guarantee.
• UL approved file no. E203000

* Other scales are available
** Specify scale required
*** For case types 077/078/079 use 10-32 UNF terminals. For M5 screw clamp terminals, use case type 075



AC Ammeter



AC Voltmeter

RMS Reading AC Voltmeters

Product Codes – Self Contained 60Hz $\pm 20\%$ (Accuracy $\pm 1\%$)***

Rating	Scaling*	4 1/2" square flange		8 3/4" square flange
		Standard case catalogue no.	Sealed case hi-shock catalogue no.	Standard case catalogue no.
150V	0-150V	•/+077-05GA-PZPZ-C6	078-05GJ-PZPZ-C6	•079-05GA-PZPZ-C6
250V	0-250V	•/+077-05GA-RSRS-C6	078-05GJ-RSRS-C6	•079-05GA-RSRS-C6
300V	0-300V	•/+077-05GA-RXRX-C6	078-05GJ-RXRX-C6	•079-05GA-RXRX-C6
500V	0-500V	•/+077-05GA-SFSF-C6	078-05GJ-SFSF-C6	•079-05GA-SFSF-C6
600V	0-600V	•/+077-05GA-SJSJ-C6	078-05GJ-SJSJ-C6	•079-05GA-SJSJ-C6
750V	0-750V	077-05GA-SMSM-C6	078-05GJ-SMSM-C6	079-05GA-SMSM-C6

For AC rectified non-RMS compensated meter, please replace the -05G in the product code with -05W.

Product Codes – Transformer Rated 50/60HZ (Accuracy $\pm 1\%$)
0.8VA @150V***

150V	0-300V	•/+077-05GA-PZRX-C6	078-05GJ-PZRX-C6	•079-05GA-PZRX-C6
150V	0-600V	•/+077-05GA-PZSJ-C6	078-05GJ-PZSJ-C6	•079-05GA-PZSJ-C6
150V	0-750V	•/+077-05GA-PZSM-C6	078-05GJ-PZSM-C6	•079-05GA-PZSM-C6
150V	0-3000V	•/+077-05GA-PZUA-C6	078-05GJ-PZUA-C6	•079-05GA-PZUA-C6
150V	0-5250V	•/+077-05GA-PZUL-C6	078-05GJ-PZUL-C6	•079-05GA-PZUL-C6
150V	0-6000V	•/+077-05GA-PZUP-C6	078-05GJ-PZUP-C6	•079-05GA-PZUP-C6
150V	0-9000V	•/+077-05GA-PZUY-C6	078-05GJ-PZUY-C6	•079-05GA-PZUY-C6
150V	0-15KV	•/+077-05GA-PZWC-C6	078-05GJ-PZWC-C6	•079-05GA-PZWC-C6
150V	0-18KV	•/+077-05GA-PZWD-C6	078-05GJ-PZWD-C6	•079-05GA-PZWD-C6
150V	0-45KV	•/+077-05GA-PZWJ-C6	078-05GJ-PZWJ-C6	•079-05GA-PZWJ-C6
250V	0-600V	•/+077-05GA-RSSJ-C6	078-05GJ-RSSJ-C6	•079-05GA-RSSJ-C6

For AC rectified non-RMS compensated meter, please replace the -05G in the product code with -05W.

Product Codes – Expanded Scale - Moving Coil Zener Diode***
(Accuracy $\pm 0.3\%$ of Mid-scale Value) Self Contained, 20-1000Hz

110-130V	110-130V	077-05YA-PNPN-C6	078-05YJ-PNPN-C6	079-05YA-PNPN-C6
110-130V	To suit PT	077-05YA-PN**-C6	078-05YJ-PN**-C6	079-05YA-PN**-C6

AC Voltmeter – Expanded Scale



Product Codes – Instantaneous AC Voltmeter***
with Instantaneous Maximum Reading Slave Pointer

150V	To suit PT	077-05XA-PZ**-C6		
250V	To suit PT	077-05XA-RS**-C6		
300V	To suit PT	077-05XA-RX**-C6		

077 moving iron ammeters and voltmeters available as listed above.

• UL approved file no. E203000

* Other scales are available

** Specify scale required

*** For case types 077/078/079 use 10-32 UNF terminals. For M5 screw clamp terminals, use case type 075

DC Ammeters

Product Codes – Self Contained (Accuracy ±1%)* ** *

Rating	Scaling*	4 1/2" square flange		8 3/4" square flange
		Standard case catalogue no.	Sealed case hi-shock catalogue no.	Standard case catalogue no.
0-200µA	0-200µA	•/+077-05AA-EAEA	078-05AJ-EAEA	•079-05AA-EAEA
0-300µA	0-300µA	•/+077-05AA-EEEE	078-05AJ-EEEE	•079-05AA-EEEE
0-500µA	0-500µA	•/+077-05AA-EMEM	078-05AJ-EMEM	•079-05AA-EMEM
0-800µA	0-800µA	•/+077-05AA-EWEW	078-05AJ-EWEW	•079-05AA-EWEW
0-1mA	0-1mA	•/+077-05AA-FAFA	078-05AJ-FAFA	•079-05AA-FAFA
0-2mA	0-2mA	•/+077-05AA-FGFG	078-05AJ-FGFG	•079-05AA-FGFG
0-5mA	0-5mA	•/+077-05AA-FXFX	078-05AJ-FXFX	•079-05AA-FXFX
0-10mA	0-10mA	•/+077-05AA-HAHA	078-05AJ-HAHA	•079-05AA-HAHA
0-20mA	0-20mA	•/+077-05AA-HFHF	078-05AJ-HFHF	•079-05AA-HFHF
0-30mA	0-30mA	•/+077-05AA-HMHM	078-05AJ-HMHM	•079-05AA-HMHM
0-50mA	0-50mA	•/+077-05AA-HXHY	078-05AJ-HXHY	•079-05AA-HXHY
0-100mA	0-100mA	•/+077-05AA-JRJR	078-05AJ-JRJR	•079-05AA-JRJR
0-200mA	0-200mA	•/+077-05AA-KAKA	078-05AJ-KAKA	•079-05AA-KAKA
0-300mA	0-300mA	•/+077-05AA-KGKG	078-05AJ-KGKG	•079-05AA-KGKG
0-500mA	0-500mA	•/+077-05AA-KMKM	078-05AJ-KMKM	•079-05AA-KMKM
0-800mA	0-800mA	•/+077-05AA-KWKW	078-05AJ-KWKW	•079-05AA-KWKW
0-1A	0-1A	•/+077-05AA-LALA	078-05AJ-LALA	•079-05AA-LALA
0-5A	0-5A	•/+077-05AA-LSLS	078-05AJ-LSLS	•079-05AA-LSLS
0-10A	0-10A	•/+077-05AA-MTMT	078-05AJ-MTMT	•079-05AA-MTMT
0-15A	0-15A	•/+077-05AA-NDND	078-05AJ-NDND	•079-05AA-NDND
0-20A	0-20A	•/+077-05AA-NGNG	078-05AJ-NGNG	•079-05AA-NGNG
0-30A	0-30A	•/+077-05AA-NLNL	078-05AJ-NLNL	•079-05AA-NLNL

Product Codes – Milliammeters - Suppressed Zero, No Zero Set Unless Specified* ** *

1/5mA	To Suit	•/+077-05RA-GM**	078-05RJ-GM**	•079-05RA-GM**
4/20mA	To Suit	•/+077-05RA-HG**	078-05RJ-HG**	•079-05RA-HG**
10/50mA	To Suit	•/+077-05RA-HZ**	078-05RJ-HZ**	•079-05RA-HZ**

Product Codes – Shunt Rated (Accuracy ±1%)* ** *

50mV (4mA)	To suit shunt rating	•/+077-05AA-EY**	078-05AJ-EY**	079-05AA-EY**
50-0-50mV		•/+077-05CA-GB**	078-05CJ-GB**	079-05CA-GB**
100mV (4mA)		•/+077-05AA-GB**	078-05AJ-GB**	079-05AA-GB**
100-0-100mV		•/+077-05CA-GM**	078-05CJ-GM**	079-05CA-GM**

Product Codes – Zero Left For Use With 50mV Shunts and 0.05 Ohm Shunt Leads*** and ****

50mV	0-15A	•/+077-05AA-EYND	078-05AJ-EYND	079-05AA-EYND
50mV	0-20A	•/+077-05AA-EYNG	078-05AJ-EYNG	079-05AA-EYNG
50mV	0-30A	•/+077-05AA-EYNL	078-05AJ-EYNL	079-05AA-EYNL
50mV	0-40A	•/+077-05AA-EYNP	078-05AJ-EYNP	079-05AA-EYNP
50mV	0-75A	•/+077-05AA-EYPB	078-05AJ-EYPB	079-05AA-EYPB
50mV	0-100A	•/+077-05AA-EYPK	078-05AJ-EYPK	079-05AA-EYPK
50mV	0-150A	•/+077-05AA-EYPZ	078-05AJ-EYPZ	079-05AA-EYPZ
50mV	0-200A	•/+077-05AA-EYRL	078-05AJ-EYRL	079-05AA-EYRL
50mV	0-300A	•/+077-05AA-EYRX	078-05AJ-EYRX	079-05AA-EYRX
50mV	0-400A	•/+077-05AA-EYSC	078-05AJ-EYSC	079-05AA-EYSC
50mV	0-500A	•/+077-05AA-EYSF	078-05AJ-EYSF	079-05AA-EYSF
50mV	0-750A	•/+077-05AA-EYSM	078-05AJ-EYSM	079-05AA-EYSM
50mV	0-1000A	•/+077-05AA-EYSS	078-05AJ-EYSS	079-05AA-EYSS
50mV	0-1200A	•/+077-05AA-EYSU	078-05AJ-EYSU	079-05AA-EYSU
50mV	0-1500A	•/+077-05AA-EYTC	078-05AJ-EYTC	079-05AA-EYTC
50mV	0-2000A	•/+077-05AA-EYTM	078-05AJ-EYTM	079-05AA-EYTM
50mV	0-3000A	•/+077-05AA-EYUA	078-05AJ-EYUA	079-05AA-EYUA



DC Ammeter

Intrinsically safe milliammeters
(accuracy ±1%)
ISSEP certified

Rating	Standard case catalogue no.
1mA DC	077-11AF-FA**
5mA DC	077-11AF-FX**
10mA DC	077-11AF-HA**
20mA DC	077-11AF-HF**
4/20mA DC	077-11RFHG**

** State scale marking as required

- UL approved file no. E203000

Specify shunt lead resistance value if in excess of 0.05 ohms for calibration purposes.

DC shunt rated ammeters have thermistor circuit ambient temperature compensation. Separate shunt and shunt leads are not included.

* Other scales are available

** Specify scale required.

*** Other mV ratings and scale options available upon request.

**** For case types 077/078/079 use 10-32 UNF terminals. For M5 screw clamp terminals, use case type 075.



DC Voltmeter

DC Voltmeters

Product Codes – Sensitivity 1000 Ohms / Volt (Accuracy $\pm 1\%$)***

Rating	Scaling*	4 1/2" square flange		8 3/4" square flange
		Standard case catalogue no.	Sealed case hi-shock catalogue no.	Standard case catalogue no.
50mV-800V	To suit	•/+077-05VA-**	078-05VJ-**	079-05VA-**
0-15V	0-15V	•/+077-05VA-NDND	078-05VJ-NDND	079-05VA-NDND
0-30V	0-30V	•/+077-05VA-NLNL	078-05VJ-NLNL	079-05VA-NLNL
0-50V	0-50V	•/+077-05VA-NTNT	078-05VJ-NTNT	079-05VA-NTNT
0-75V	0-75V	•/+077-05VA-PBPB	078-05VJ-PBPB	079-05VA-PBPB
0-150V	0-150V	•/+077-05VA-PZPZ	078-05VJ-PZPZ	079-05VA-PZPZ
0-300V	0-300V	•/+077-05VA-RXR X	078-05VJ-RXR X	079-05VA-RXR X
0-400V	0-400V	•/+077-05VA-SCSC	078-05VJ-SCSC	079-05VA-SCSC
0-500V	0-500V	•/+077-05VA-SFSF	078-05VJ-SFSF	079-05VA-SFSF
0-600V	0-600V	•/+077-05VA-SJSJ	078-05VJ-SJSJ	079-05VA-SJSJ
0-750V	0-750V	077-05VA-SMSM	078-05VJ-SMSM	079-05VA-SMSM
0-800V	0-800V	077-05VA-SNSN	078-05VJ-SNSN	079-05VA-SNSN

Product Codes – Zero Centre - Sensitivity 2000 Ohms / Volt (Accuracy $\pm 1\%$)***

150-0-150V	150-0-150V	•/+077-05NA-RXR X	078-05NJ-RXR X	079-05NA-RXR X
300-0-300V	300-0-300V	•/+077-05NA-SJSJ	078-05NJ-SJSJ	079-05NA-SJSJ
500-0-500V	500-0-500V	•/+077-05NA-SSSS	078-05NJ-SSSS	079-05NA-SSSS
600-0-600V	600-0-600V	•/+077-05NA-SUSU	078-05NJ-SUSU	079-05NA-SUSU

Product Codes – Suppressed Zero***

1 - 5V	To suit	•/+077-05S-LM	078-05S-LM	•079-05S-LM
--------	---------	---------------	------------	-------------



Frequency Meter

Frequency Meters

Product Codes –120V Self Contained***

Rating	Scaling*	4 1/2" square flange		8 3/4" square flange
		Standard case catalogue no.	Sealed case hi-shock catalogue no.	Standard case catalogue no.
50Hz+/-0.15	45-55Hz	•/+077-41LA-PNAG-AG	078-41LJ-PNAG-AG	•079-41LA-PNAG-AG
50Hz+/-0.15	46-54Hz	•/+077-41LA-PNAH-AH	078-41LJ-PNAH-AH	•079-41LA-PNAH-AH
50Hz+/-0.25	45-65Hz	•/+077-41LA-PNAJ-AJ	078-41LJ-PNAJ-AJ	•079-41LA-PNAJ-AJ
60Hz+/-0.25	50-70Hz	•/+077-41LA-PNAL-AL	078-41LJ-PNAL-AL	•079-41LA-PNAL-AL
60Hz+/-0.15	55-65Hz	•/+077-41LA-PNAN-AN	078-41LJ-PNAN-AN	•079-41LA-PNAN-AN
60Hz+/-0.15	56-64Hz	•/+077-41LA-PNAO-AO	078-41LJ-PNAO-AO	•079-41LA-PNAO-AO
60Hz+/-0.08	58-62Hz	•/+077-41LA-PNAT-AG	078-41LJ-PNAG-AG	•079-41LA-PNAG-AG
400Hz+/-1.3	350-450Hz	•/+077-41LA-PNBH-BH	078-41LJ-PNBH-BH	•079-41LA-PNBH-BH
400Hz+/-1.25	360-440Hz	•/+077-41LA-PNBI-BI	078-41LJ-PNBI-BI	•079-41LA-PNBI-BI
400Hz+/-0.8	380-420Hz	•/+077-41LA-PNBK-BK	078-41LJ-PNBK-BK	079-41LA-PNBK-BK

For alternative voltage rating 200-250V, use code RN instead of PN

For alternative voltage rating 380-480V, use code SE instead of PN

• UL approved file no. E203000

* Other scales are available

** Specify scale required

*** For case types 077/078/079 use 10-32 UNF terminals. For M5 screw clamp terminals, use case type 075

Thermal Maximum Demand Directly Heated Element Type

Meter indicates the maximum average ampere demand of a system. A red resettable slave pointer is driven upscale by the indicating pointer to show maximum average current value since the previous setting. 4 1/2" square flange.

Specifications

Burden:	3.5VA with limiting CT, 2.5VA without limiting CT
Time lag:	15 minutes
Accuracy:	3%, 50 or 60Hz

Product Codes

5/6A with 20% overload and internal limiting CT	CT 077-16EU-LS**
5A - without overload, with internal limiting CT	•077-16EU-LS** - NO

Thermal / Instantaneous Maximum Demand Ammeter (MDA)

Allows instantaneous current values to be read independently of the thermal indicator. This meter combines a thermal movement with a rugged short-scale iron vane indicator.

Specifications

Burden:	4VA with limiting CT, 3VA without limiting CT
Time lag:	15 minutes
Accuracy:	3% MDA, 2% iron vane, 50 or 60Hz

Product Codes

Thermal / instantaneous MDA	
5/6A with 20% overload scale and internal limiting CT	•077-16FU-LS**
5A - without 20% overload scale, with internal limiting CT	•077-16FU-LS** - NO
Dual range - thermal instantaneous	
3/6A - with 20% overload scale	•077-16FU-LK**
2.5/5A - without 20% overload scale	•077-16FU-LK** - NO
6/12A with 20% overload scale and internal limiting CT	•077-16FU-LV**
5/10A - without 20% overload scale with internal limiting CT	•077-16FU-LV** - NO

Instantaneous Maximum Demand Ammeter with Slave Pointer

Designed for compatibility with other 4 1/2" switchboard meters, this instrument enhances panel appearance and indicates maximum instantaneous load current values. A long-scale high torque, taut band iron vane movement drives the red slave pointer.

Specifications

Burden:	5VA
Accuracy:	1% 50 or 60Hz

Product Code

5A - without overload scale	077-08DA-LS**
-----------------------------	---------------

- ** Specify scale required
- UL approved



AC Maximum Demand Ammeter



Thermal Instantaneous Maximum Demand Ammeter



Instantaneous Maximum Demand Ammeter



AC Wattmeters and VArmeters

The Crompton 70 series of AC wattmeters and VArmeters incorporate a DC moving coil taut band indicator with the Crompton designed micro-circuit watt transducer PCB to read power on single or three-phase systems. VArmeters can be supplied with internal or external phase shifter according to user preferences. The most frequently selected wattmeter scale marking for common current and voltage transformers are listed on the following pages. In addition, these instruments may be supplied with zero-left or center-zero scales at the same list price.

Scaling

Wattmeter and VArmeter current circuits should have equal carrying capacity because they are frequently connected in series. This means that the sum of the left and right end-scale values of the VArmeters should be equal to or greater than the full scale value of the wattmeter (or have higher end-scale values if the instruments are center or offset-zero). Instruments measuring 10,000 kilowatts and over are marked in megawatts. Center-zero or offset-zero watt and VArmeters are marked "IN" for left deflection and "OUT" for right deflection. Customised scales may be calculated for wattmeters and VArmeters not listed on the charts. Scales for watts must be one of the standard full-scale dial markings shown in the charts.

Calibration

For full load value of watts or VAr, assuming unity power factor:

1-phase 2-wire watts = amps x volts

3-phase 3-wire watts = amps x line-to-line volts x $\sqrt{3}$

3-phase 4-wire watts = amps x line-to-neutral volts x 3

Minimum scale values are obtained by multiplying resultant watts, using the above formula x 0.7 and selecting next higher standard scale.

For maximum scale value, multiply x 1.3 and select the next lowest standard.

If scale calculates to an exact listed value, use this value rather than the next higher or lower value.

Note: When ordering wattmeters and VArmeters, please specify CT ratio, VT ratio and required scale.

Specifications

Burden per element:	Current circuit: 2VA Voltage circuit: 1VA
Accuracy:	Class 1.0
Ambient range:	0° to +60°C, (32° to 140°F) standard calibration 20°C (68°F)
Ambient influence:	0.05% per 1°C maximum
Overloads-current:	10 x rating for 5 seconds., 1.2 x continuously
Voltage influence:	2 x rating for 5 seconds., 1.2 x continuously Voltage Accuracy maintained, 80-110% rated voltage
Power factor influence:	Accuracy maintained 0.1 lag to 0.1 lead
Enclosure code:	077: IP54 optional IP55 078: IP67 079: IP54 optional IP55
Response time:	077,078: approximately 2.5 seconds 079: approximately 3.5 seconds
Dielectric test:	Live parts to case including panel 2600V RMS for 1 minute

Wattmeter/VArmeter Scale Selector Guide

		120	208	240	480	600	2400	3600	4200	4800	6000	7200	8400
Primary potential transformer voltage system		(1:1)	(1.73:1)	(2:1)	(4:1)	(5:1)	(20:1)	(30:1)	(35:1)	(40:1)	(50:1)	(60:1)	(70:1)
3-phase 3-wire (L-L) system voltage		120	208	240	480	600	2400	3600	4200	4800	6000	7200	8400
3-phase 4-wire (L-N) current transformer		69	120	139	277	347	1390	2100	2400	2770	3500	4160	4800
RATIO	Normal	5KW	10KW	10KW	20KW	25KW	100KW	150KW	175KW	200KW	250KW	300KW	350KW
25/5	Max.	6	10	12	25	30	120	200	200	250	300	400	450
(5:1)	Min.	3	5	6	12.5	15	60	100	100	125	150	200	225
RATIO	Normal	10KW	20KW	20KW	40KW	50KW	200KW	300KW	350KW	400KW	500KW	600KW	700KW
50/5	Max.	12	20	25	50	60	250	400	450	500	600	800	900
(10:1)	Min.	6	10	12.5	25	30	125	200	250	250	300	400	450
RATIO	Normal	15KW	25KW	30KW	60KW	75KW	300KW	500KW	500KW	600KW	750KW	900KW	1000KW
75/5	Max.	20	30	40	80	100	400	600	700	800	1000	1200	1200
(15:1)	Min.	10	15	20	40	50	200	300	350	400	500	600	600
RATIO	Normal	20KW	30KW	40KW	75KW	100KW	400KW	600KW	700KW	800KW	1000KW	1200KW	1200KW
100/5	Max.	25	40	50	100	120	500	800	900	1000	1200	1500	1500
(20:1)	Min.	12.5	20	25	50	60	250	400	450	500	600	750	750
RATIO	Normal	30KW	50KW	50KW	100KW	150KW	600KW	800KW	1000KW	1200KW	1500KW	1800KW	2000KW
150/5	Max.	40	70	75	150	200	800	1200	1200	1500	2000	2400	2500
(30:1)	Min.	20	35	35	75	100	400	600	600	750	1000	1000	1250
RATIO	Normal	40KW	75KW	75KW	150KW	200KW	800KW	1200KW	1200KW	1500KW	2000KW	2500KW	3000KW
200/5	Max.	50	80	100	200	250	1000	1500	1500	2000	2500	3000	3500
(40:1)	Min.	25	40	50	100	125	500	750	750	1000	1250	1500	1500
RATIO	Normal	70KW	100KW	100KW	200KW	300KW	1200KW	1500KW	2000KW	2500KW	3000KW	3500KW	4500KW
300/5	Max.	75	120	150	300	400	1500	2000	2500	3000	4000	4000	5000
(60:1)	Min.	35	60	75	150	200	750	1000	1250	1500	2000	2000	2500
RATIO	Normal	75KW	125KW	150KW	300KW	400KW	1500KW	2500KW	3000KW	3000KW	4000KW	5000KW	6000KW
400/5	Max.	100	150	200	400	500	2000	3000	3600	4000	5000	6000	7000
(80:1)	Min.	50	75	100	200	250	1000	1500	1500	2000	2500	3000	3500
RATIO	Normal	125KW	200KW	200KW	450KW	600KW	2000KW	3000KW	4000KW	5000KW	6000KW	7500KW	8000KW
600/5	Max.	150	250	300	600	800	3000	4000	5000	6000	8000	8000	10MW
(120:1)	Min.	75	125	150	300	400	1500	2000	2500	3000	4000	4000	5000KW
RATIO	Normal	150KW	250KW	300KW	600KW	800KW	3000KW	5000KW	6000KW	6000KW	8000KW	10MW	12MW
800/5	Max.	200	350	400	800	1000	4000	6000	7500	8000	10MW	12	15
(160:1)	Min.	100	175	200	400	500	2000	3000	3000	4000	5000KW	6000KW	7500KW
RATIO	Normal	200KW	350KW	400KW	800KW	1000KW	4000KW	6000KW	6000KW	8000KW	10MW	12MW	15MW
1000/5	Max.	250	450	500	1000	1200	5000	8000	8000	10MW	12	15	18
(200:1)	Min.	125	225	250	500	600	2500	4000	4000	5000KW	6000KW	7500KW	10
RATIO	Normal	250KW	400KW	500KW	1000KW	1200KW	5000KW	7000KW	8000KW	10MW	12MW	15MW	10MW
1200/5	Max.	300	500	600	1200	1500	6000	8000	10MW	12	15	18	20
(240:1)	Min.	150	250	300	600	750	3000	4000	5000KW	6000KW	7500KW	10	10
RATIO	Normal	300KW	500KW	600KW	1200KW	1500KW	6000KW	10MW	10MW	12MW	15MW	20MW	20MW
1500/5	Max.	400	700	750	1500	2000	8000	12	12	15	20	20	25
(300:1)	Min.	200	350	375	1000	1000	4000	6000KW	6000KW	7500KW	10	10	12.5
RATIO	Normal	400KW	750KW	800KW	1600KW	2000KW	8000KW	12MW	12MW	15MW	20MW	25MW	30MW
2000/5	Max.	500	800	1000	2000	2500	10MW	15	15	20	25	30	35
(400:1)	Min.	250	400	500	750	1250	5000	7500KW	7500KW	10	12.5	15	20
RATIO	Normal	750KW	1000KW	1200KW	2000KW	3000KW	12MW	18MW	20MW	25MW	30MW	35MW	40MW
3000/5	Max.	800	1200	1500	3000	4000	15	20	25	30	40	40	50
(600:1)	Min.	400	600	750	1500	2000	7500KW	10	12.5	15	20	20	25
RATIO	Normal	800KW	1200KW	1500KW	3000KW	4000KW	15MW	20MW	25MW	30MW	40MW	50MW	50MW
4000/5	Max.	1000	1500	2000	4000	5000	20	30	30	40	50	60	75
(800:1)	Min.	500	750	1000	2000	2500	10	15	15	20	25	30	40
RATIO	Normal	1000KW	1500KW	2000KW	4000KW	5000KW	20MW	30MW	20MW	40MW	50MW	60MW	75MW
5000/5	Max.	1250	2000	2500	5000	6000	25	40	25	50	60	80	80
(1000:1)	Min.	500	1000	1250	2500	3000	12.5	20	12.5	25	30	40	40
RATIO	Normal	1200KW	2000KW	2500KW	5000KW	6000KW	25MW	35MW	40MW	50MW	60MW	60MW	80MW
6000/5	Max.	1500	2500	3000	3000	8000	30	40	50	60	80	80	100
(1200:1)	Min.	750	1250	1500	1500	4000	15	20	25	30	40	40	50

Wattmeter/VArmeter Scale Selector Guide

		12KV	14.4KV	24KV	34.5KV	38KV	46KV	92KV	115KV	138KV	345KV	765KV
Primary potential transformer voltage system		(100:1)	(120:1)	(200:1)	(300:1)	(330:1)	(400:1)	(800:1)	(1000:1)	(1200:1)	(3000:1)	(6000:1)
3-phase 3-wire (L-L) system voltage		12KV	14.4KV	24KV	34.5KV	38KV	46KV	92KV	115KV	138KV	345KV	765KV
3-phase 4-wire (L-N) current transformer		6900	8300	13.8KV	20KV	22KV	26.5KV	53KV	66KV	80KV	200KV	440KV
RATIO 25/5 (5:1)	Normal	500KW	600KW	1000KW	1500KW	1500KW	1500KW	3000KW	5000KW	6000KW	15MW	30MW
	Max.	650	800	1200	1500	2000	2500	200	200	250	300	400
	Min.	325	400	600	750	1000	1250	100	100	125	150	200
RATIO 50/5 (10:1)	Normal	1000KW	1200KW	2000KW	3000KW	3000KW	3500KW	8000KW	10MW	12MW	30MW	60MW
	Max.	1200	1500	2500	3500	4000	5000	10MW	12	15	35	80
	Min.	600	750	1250	1750	2000	2500	5000KW	6000KW	7500KW	15	40
RATIO 75/5 (15:1)	Normal	1500KW	1800KW	3000KW	4000KW	5000KW	5000KW	10MW	15MW	15MW	45MW	100MW
	Max	2000	2000	4000	5000	6000	7500	15	15	20	50	125
	Min.	1000	1000	2000	2500	3000	3000	7500KW	7500KW	10	25	50
RATIO 100/5 (20:1)	Normal	2000KW	2500KW	4000KW	6000KW	6000KW	7500KW	15MW	20MW	25MW	60MW	125MW
	Max.	2500	3000	5000	7500	8000	10MW	20	25	30	70	150
	Min.	1250	1500	2500	3000	4000	5000KW	10	12.5	15	35	75
RATIO 150/5 (30:1)	Normal	3000KW	3500KW	6000KW	10MW	10MW	10MW	20MW	30MW	35MW	90MW	200MW
	Max.	4000	4000	4000	10	12	15	30	35	40	100	250
	Min.	2000	2000	2000	5000KW	6000KW	7500KW	15	15	20	50	100
RATIO 200/5 (40:1)	Normal	4000KW	4500KW	8000KW	12MW	12MW	15MW	30MW	35MW	50MW	100MW	250MW
	Max.	5000	6000	5000	15	15	20	40	50	60	150	300
	Min.	2500	3000	2500	7500KW	7500KW	10	20	25	30	75	150
RATIO 300/5 (60:1)	Normal	6000KW	7000KW	12MW	18MW	18MW	20MW	45MW	60MW	75MW	150MW	400MW
	Max.	8000	8000	15	20	25	30	60	75	80	200	500
	Min.	4000	4000	7.5	10	12.5	15	30	30	40	100	250
RATIO 400/5 (80:1)	Normal	8000KW	10MW	15MW	24MW	25MW	30MW	60MW	80MW	100MW	200MW	500MW
	Max.	10MW	12	20	30	30	40	80	100	120	300	600
	Min.	5000KW	6000KW	10	15	15	20	40	50	60	150	300
RATIO 600/5 (120:1)	Normal	12MW	15MW	25MW	35MW	40MW	45MW	90MW	100MW	150MW	350MW	800KW
	Max.	15	18	30	40	50	60	120	150	180	450	1000
	Min.	7500KW	10	15	20	25	30	60	75	75	225	500
RATIO 800/5 (160:1)	Normal	15MW	20MW	30MW	50MW	50MW	60MW	120MW	150MW	200MW	500MW	1000MW
	Max.	20	25	40	60	60	80	150	200	200	600	1200
	Min.	10	12.5	20	30	30	40	75	100	100	300	600
RATIO 1000/5 (200:1)	Normal	20MW	25MW	40MW	50MW	60MW	75MW	150MW	200MW	250MW	600MW	1200MW
	Max.	25	30	50	60	80	100	200	250	300	750	1500
	Min.	12.5	15	25	30	40	50	100	125	150	300	750
RATIO 1200/5 (240:1)	Normal	25MW	30MW	50MW	60MW	80MW	100MW	175MW	250MW	300MW	750MW	1500MW
	Max.	30	35	60	80	100	120	200	300	350	900	2000
	Min.	15	20	30	40	50	60	100	150	175	450	1000
RATIO 1500/5 (300:1)	Normal	30MW	35MW	60MW	75MW	100MW	120MW	250MW	300MW	350MW	900MW	2000MW
	Max.	40	40	80	100	120	150	300	350	450	1000	2500
	Min.	20	20	40	50	60	75	150	175	225	500	1250
RATIO 2000/5 (400:1)	Normal	40MW	50MW	80MW	100MW	120MW	150MW	300MW	400MW	500MW	1000MW	2500MW
	Max.	50	60	100	150	150	200	400	500	600	1500	3000
	Min.	25	30	50	75	75	100	200	250	300	750	1500
RATIO 3000/5 (600:1)	Normal	60MW	75MW	100MW	150MW	200MW	200MW	400MW	600MW	700MW	1500MW	3500MW
	Max.	80	80	150	200	250	300	500	750	900	2000	5000
	Min.	40	40	75	100	125	150	250	350	450	1000	2500
RATIO 4000/5 (800:1)	Normal	80MW	100MW	150MW	200MW	250MW	300MW	500MW	800MW	1000MW	2000MW	500MW
	Max.	100	125	200	300	300	400	800	1000	1200	3000	6000
	Min.	50	60	100	150	150	200	400	500	600	1500	3000
RATIO 5000/5 (1000:1)	Normal	100MW	125MW	200MW	250MW	300MW	400MW	750MW	1000MW	1200MW	3000MW	6000MW
	Max.	120	150	250	300	400	500	1000	1200	1500	3500	8000
	Min.	60	75	125	150	200	250	500	600	750	1750	4000
RATIO 6000/5 (1200:1)	Normal	120MW	150MW	250MW	350KW	400MW	450MW	1000MW	1200MW	1500MW	3500MW	8000MW
	Max.	150	175	300	400	500	600	1200	1500	1750	4000	10000
	Min.	75	80	150	200	250	300	600	750	800	2000	5000

AC Wattmeters

**Product Codes – 1-Element, Transformer Rated. 50/60Hz.
Taut Band Integral Transducer. (Accuracy 1.0%. 50/60Hz)**

Measured system		Scales	4½" square flange		8¼" square flange
Phases Wires Amperes 1 VA max. burden Volts 1 VA max. burden			Standard case catalogue no.	Sealed case hi-shock catalogue no.	Standard case catalogue no.
		1 2 5	120V	To suit	•/+077-215A-QQ**
1 2 5	240V	To suit	077-215A-QS**	078-215J-QS**	079-215A-QS**

For connection diagram, see Fig. 21 on page 60.

**Product Codes – 2-Element, Transformer Rated. 50/60Hz.
Taut Band Integral Transducer (Accuracy 1.0%. 50/60Hz)**

3 3 5	120V	To suit	•/+077-218A-QQ**	078-218J-QQ**	•079-218A-QQ**
3 3 5	208V	To suit	•/+077-218A-QR**	078-218J-QR**	•079-218A-QR**
3 3 5	240V	To suit	•/+077-218A-QS**	078-218J-QS**	079-218A-QS**
3 3 5	380V	To suit	•/+077-218A-QX**	078-218J-QX**	079-218A-QX**
3 3 5	480V	To suit	•/+077-218A-QT**	078-218J-QT**	079-218A-QT**

For connection diagram, see Fig. 25 on page 60.

**Product Codes – 2½-Element, Transformer Rated. 50/60Hz.
Taut Band Integral Transducer (Accuracy 1.0%. 50/60Hz)**

3 4 5	69V	To suit	•/+077-219A-QL**	078-219J-QL**	•079-219A-QL**
3 4 5	120V	To suit	•/+077-219A-QQ**	078-219J-QQ**	•079-219A-QQ**
3 4 5	277V	To suit	077-219A-QY**	078-219J-QY**	079-219A-QY**
3 4 5	346V	To suit	077-219A-QZ**	078-219J-QZ**	079-219A-QZ**

For connection diagram, see Fig. 28 on page 60.

Product Codes – Phase Shifting Transformers

For use with above Wattmeters, when VAR measurement with external phase shifter is required.

3 3	120V		855-956A-PR	855-956J-PR	855-956A-PR
3 4	120V		855-957A-PR	855-957J-PR	855-957A-PR
3 4	69V		855-957A-NZ	855-957J-NZ	855-957A-NZ

AC VAr meters

**Product Codes – 2-Element, Transformer Rated. 50/60Hz.
Taut Band. Integral Transducer. (Accuracy 1.0%. 50/60Hz)**

3 3 5	120V	To suit	•/+077-31LA-QQ**	078-31LJ-QQ**	
3 3 5	208V	To suit	•/+077-31LA-QR** -C6	078-31LJ-QR**	
3 3 5	240V	To suit	077-31LA-QS**	078-31LJ-QS**	
3 3 5	380V	To suit	077-31LA-QX**	078-31LJ-QX**	
3 3 5	480V	To suit	077-31LA-QT**	078-31LJ-QT**	

For connection diagram, see Fig. 32 on page 61.

**Product Codes – 2½-element, transformer rated. 50/60Hz.
Taut Band. Integral transducer (Accuracy 1.0%. 50/60Hz)**

3 4 5	120V	To suit	•/+077-31UA-QQ**	078-31UJ-QQ**	•079-31UA-QQ**
3 4 5	208V	To suit	077-31UA-QR**	078-31UJ-QR**	•079-31UA-QR**
3 4 5	480V	To suit	077-31UA-QT**	078-31UJ-QT**	079-31UA-QT**

For connection diagram, see Fig. 32 on page 61

• UL approved file no. E203000

** Specify CT (Current Transformer) and VT (Voltage Transformer) ratios if used,
and preferred scale at time of ordering.



AC Wattmeter

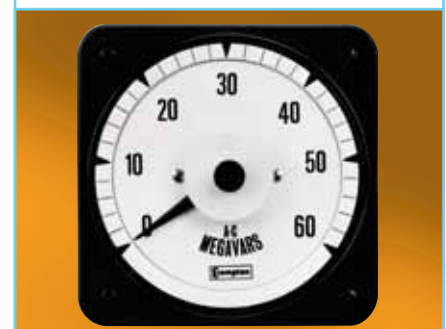

AC VAr meter



RTD Temperature Meter

RTD Temperature Meters*

Product Codes – Span Accuracy of 1.0%

Self-contained for 10 ohm copper or 100 ohm platinum RTD (Resistance Temperature Detector) - Specify copper or platinum at time of ordering.

Rating	Scaling*	4 1/2" square flange	
		Standard case catalogue no.	Sealed case hi-shock catalogue no.
110/130V 50/60Hz	20-140°C	077-45RA-**-QF-PQ	078-45RJ-**-QF-PQ
110/130V 50/60Hz	0-150°C	077-45RA-**-QE-PQ	078-45RJ-**-QE-PQ
110/130V 50/60Hz	0-200°C	077-45RA-**-QG-PQ	078-45RJ-**-QG-PQ

For connection diagrams, see Fig. 17 on page 59.

Thermocouple Temperature Meters

Product Code – Span Accuracy of 1.0%

Meters are suitable for J and K type cold junction compensation and include thermocouple break indication. Specify J or K type and temperature at time of ordering.

Rating	4 1/2" square flange standard case catalogue no.
110/130V 50/60Hz	077-45TA-**-PM

For connection diagrams, see Fig. 18 on page 59.

Tap Position Indicator

Product Code

Indicator shows transformer tap, hoist or valve position a using 3-wire system for 1-18 tap positions with 400 ohm steps.

Rating	Scaling*	4 1/2" square flange		8 3/4" square flange
		Standard case catalogue no.	Sealed case hi-shock catalogue no.	Standard case catalogue no.
110/220/240V 50/60Hz	1-18 taps	077-45P-	-	-

For connection diagrams, see Fig. 20 on page 60.

Select nearest higher rated voltmeter and specify requirement

- UL approved file no. E203000
- JT for J type, KT for K type thermocouple
- * Other ranges available on request
- Consult with the factory.
- ** RI for 10 ohm copper or R2 for 100ohm platinum.
- *** Specify input and scale.

Elapsed Time Meters

Product Codes – 99,999.99 hours, Non Reset. Burden 2.5VA.
50 or 60Hz

Synchronous motor running time meter with a non resettable indicator.

Rating	4½" square flange		8¾" square flange
	Standard case catalogue no.	Sealed case hi-shock catalogue no.	Standard case catalogue no.
110/130V 50Hz	•077-155A-PNZH-C5	078-155J-PNZH-C5	Not available
200/250V 50Hz	•077-155A-RNZH-C5	078-155J-RNZH-C5	Not available
480V 50Hz	•077-155A-SEZH-C5	078-155J-SEZH-C5	Not available
110/130V 60Hz	•077-156A-PNZH-C6	078-156J-PNZH-C6	Not available
200/250V 60Hz	•077-156A-RNZH-C6	078-156J-RNZH-C6	Not available
480V 60Hz	•077-156A-SEZH-C6	078-156J-SEZH-C6	Not available
12/24/40/110V DC	077-151A-		



Elapsed Time Meter

AC Phase Sequence, Phase Failure Indicators

Product Codes – Neon Bulb Type. Burden 2.5VA

Two neon bulbs for phase sequence indication - first marked the caption "correct 1-2-3", the second marked "incorrect 3-2-1". Three neon bulbs for phase failure indication - first marked 1, second marked 2, third marked 3.

Rating	4½" square flange		8¾" square flange
	Standard case catalogue no.	Sealed case hi-shock catalogue no.	Standard case catalogue no.
100/150V 50/60Hz	077-12PA-P2C6	Not available	Not available
151/300V 50/60Hz	077-12PA-P3C6	Not available	Not available
301/500V 50/60Hz	077-12PA-P4C6	Not available	Not available



AC Phase Sequence and Phase Failure Indicator

For connection diagrams, see Fig. 1 on page 58.

DC Indicators for Tachometer Generators

Product Code

Rating	4½" square flange		8¾" square flange
	Standard case catalogue no.	Sealed case hi-shock catalogue no.	Standard case catalogue no.
DC Volts	077-052A-**	078-052J-***	079-052A-***

Select nearest higher rated voltmeter and specify requirement

- UL approved file no. E203000
- JT for J type, KT for K type thermocouple
- * Other ranges available upon request - Consult with the factory.
- ** RI for 10 ohm or R2 for 100 ohm platinum.
- *** Specify input and scale



AC Power Factor Meter

AC Power Factor Meter

Specifications

Ratings, self-contained:	Current windings 5A. Voltage windings minimum 50V, maximum 600V
Accuracy:	Balanced Load: Class 1, Unbalanced Load: Class 3
Overshoot:	33%
External temperature influence:	0.5% fid max.
External field influence:	3% fid max.
Frequency range:	50Hz or 60Hz standard, 25-3000Hz optional (Specify)
Frequency influence:	Single phase instruments, 59 to 61Hz 1.0% fid max. Polyphase instruments $\pm 10\%$ deviation from 69Hz: 1.0%
Overload capacity: and 25% indefinitely.	Current coils 1000% momentarily, 100% for 15 minutes Voltage circuits 25% indefinitely.
Burdens:	Each current circuit, 1.5VA approx. Each voltage circuit 1VA approx. Measuring systems 077-427 - 3- or 4-wire
Ranges available:	Lag 0.5-1 - 0.5 lead power factor Lag 0.2-1 - 0.8 lead power factor

JIS dimension product available on request.

Product Codes – Balanced Load (Accuracy $\pm 1\%$)

Measured system		Scales	4 1/2" square flange		8 3/4" square flange		
Phases	Wires		Standard case catalogue no.	Sealed case hi-shock catalogue no.	Standard case catalogue no.		
1	2	5	120V	0.5-1-0.5	•/+077-425A-QQAD	078-425J-QQAD	•079-425A-QQAD
1	2	5	240V	0.5-1-0.5	•/+077-425A-QSAD	078-427J-QSAD	•079-427A-QSAD
3	3/4	5	120V	0.5-1-0.5	•/+077-427A-QQAD	078-427J-QQAD	•079-427A-QAAD
3	3/4	5	208V	0.5-1-0.5	•/+077-427A-QRAD	078-427J-QRAD	•079-427A-QRAD
3	3/4	5	240V	0.5-1-0.5	•/+077-427A-QSAD	078-427J-QSAD	•079-427A-QSAD
3	3/4	5	480V	0.5-1-0.5	077-427A-QTAD	078-427J-QTAD	079-427A-QTAD

Instruments may be used on loads down to 20% of current and between 90% and 110% of voltage rating.

For connection diagrams, see Fig. 13 and 15 on page 59.

Product Codes – Unbalanced Load (Accuracy $\pm 3\%$ of scale)

Measured system		Scales	4 1/2" square flange		8 3/4" square flange		
Phases	Wires		Standard case catalogue no.	Sealed case hi-shock catalogue no.	Standard case catalogue no.		
3	3	5	120V	0.5-1-0.5	077-TFUA-QQAD	–	–
3	3	5	240V	0.5-1-0.5	077-TFUA-QSAD	–	–

Instruments may be used on loads between 50% and 110% of rated current and between 80% and 110% rated voltage.

For connection diagram, see Fig. 12 on page 59.

• UL approved file no. E203000

360° Power Factor

Specifications

Ratings, self-contained:	Current windings minimum, 0.5A, maximum 20A. Voltage windings min. 50-240V, for higher voltages of up to 480V an external box is supplied.			
Normal operating position:	On vertical panels unless otherwise specified at the time of order.			
Position influence:	Not more than 1% of scale length for up to 60° tilt from normal operating position.			
Accuracy:	Class 1.0			
Overshoot:	33%			
External temp. influence:	0.5% fid. max.			
External field influence:	3% fid. max			
Frequency influence:	Single phase instruments from 59-61Hz 1% max. fid. max. Polyphase instrument ±10% deviation from 60Hz: 1% fid. max.			
Overload capacity:	Current coils 1000% momentarily, 100% for 15 minutes, and 50% indefinitely. Voltage circuits 50% indefinitely.			
Characteristics	077-132		077-136	
	A	V	A	V
Impedance ohms:	0.162	3380	0.043	3380
Resistance ohms:	0.147	3300	0.04	3300
Resistance ohms:	0.082	750	0.016	750
Watts:	3.5	1.39	1.0	1.30
Volt-amperes:	4.05	1.42	1.07	1.42
Reactive (VAR):	2.03	0.281	0.4	0.281
Power factor:	0.86	0.96	0.93	0.98

Product Codes – 360° Rotary Power Factor

3 3/4 5 120V	0-1-0	077-136A-QQAB	078-136J-QQAB	079-136A-QQAB
3 3/4 5 208V	0-1-0	077-136A-QRAB	078-136J-QRAB	079-136A-QRAB
3 3 5 120V	0-1-0	077-132A-QQAB	078-132J-QSAB	079-132A-QSAB
3 3 5 208V	0-1-0	077-132A-QRAB	078-132J-QTAB	079-132A-QTAB

For connection diagrams, see Fig. 4, 6 and 7 on page 58.

360° rotating iron products are only suitable for use on 50 and 60 Hz systems.

3-phase 4-wire power factor meters are connected L-L ie.. 120V L-N system will be rated at 208V L-L.

Model -136 unbalanced load, -132 balanced load
 • UL approved file no. E203000



360° Power Factor Meter



360° Rotary Synchroscope

360° Rotary Synchroscope

Specifications

Rating, self-contained:	120V AC	
Frequency rating:	50 or 60Hz (specify), 400Hz optional	
Normal operating position:	On vertical panel unless otherwise specified at time of order	
Position influence:	Not more than 3.6 mechanical degrees deviation for up to 60° tilt from normal operating position.	
Accuracy:	2 degrees	
Overshoot:	33% maximum	
Response time:	3 seconds maximum for 180° deflection	
Sensitivity at synchronism:	3 electrical degrees maximum	
External field influence:	3% maximum in 5 oersted field	
Pull in frequency:	58Hz	
Drop-out frequency:	57Hz	
Dielectric test:	Live parts to case, including panel: 2600V RMS for 1 minute.	
Between running and incoming circuits:	1500V RMS for 1 minute	
Overload capacity:	50% indefinitely	
Characteristics	Incoming circuit	Running circuit
Impedance ohms:	4670	5335
Resistance ohms:	4020	5240
Resistance ohms:	2380	1058
Reactive volt amps:	1.57	0.535
Volt-amps:	3.08	2.7
Power factor:	0.86	0.98
Watts:	2.66	2.65

Product Codes – Pivot and Jewel

Rating	Scaling*	4 1/2" square flange		8 3/4" square flange
		Standard case catalogue no.	Sealed case hi-shock catalogue no.	Standard case catalogue no.
120V 50Hz	SLOW FAST	•/+077-145A-PRAE-C5	078-145J-PRAE-C5	•079-145A-PRAE-C5
120V 60Hz	SLOW FAST	•/+077-146A-PRAE-C6	078-146J-PRAE-C6	•079-146A-PRAE-C6
120V 400Hz	SLOW FAST	077-144A-PRAE-C4	078-144J-PRAE-C4	079-144A-PRAE-C4

For connection diagrams, see Fig. 10 on page 59.

Alternate voltage of 240V, use code RR instead of PR.

• UL approved file no. E203000

360° AC LED Synchroscope

Specifications

Voltage:	120, 240, 480 Volts AC or via PT
Frequency:	40/65Hz
Burden @ 60Hz:	4VA maximum Suitable for single or three-phase systems
Safety:	IEC1010-1(300V AC RMS installation degree 2)
Dielectric:	4kV RMS for 1 minute
Isolation:	BUS/GEN/RELAY
Vibration:	Meets Lloyds shipping specifications

Product Codes

Rating	Scaling	4 1/2" square flange standard case catalogue no.
120V 40/65Hz	SLOW FAST	077-14AU-PQYY-FQ
240V 40/65Hz	SLOW FAST	077-14AU-RRYY-FQ
480V 40/65Hz	SLOW FAST	077-14AU-SEYY-FQ

For connection diagrams, see Fig. 8 on page 58.



360° AC LED Synchroscope

AC Synchrocheck Relay and LED 360° Synchroscope

Specifications

Voltage:	110/120V (115V nominal) 220/240V (230V nominal) 380/480V (430V nominal)
Phase difference:	+0 to 20° ±1°
Voltage difference:	+0 to 20% ±2%
Time delay:	0 to 2.5 seconds +10%

Product Codes

Rating	Scaling	4 1/2" square flange standard case catalogue no.
Live Bus 110/120V 40/65Hz 220/240V 40/65Hz 380/480V 40/65Hz	SLOW FAST SLOW FAST SLOW FAST	077-14GU-POYY-FQ 077-14GU-RSYY-FQ 077-14GU-SZYY-FQ
Dead Bus 110/120V 40/65Hz 220/240V 40/65Hz 380/480V 40/65Hz	SLOW FAST SLOW FAST SLOW FAST	077-14HU-POYY-FQ 077-14HU-RSYY-FQ 077-14HU-SZYY-FQ
Live Bus 120V 40/65Hz 240V 40/65Hz 480V 40/65Hz	SLOW FAST SLOW FAST SLOW FAST	077-14LU-PQYY-FQ 077-14LU-RRYY-FQ 077-14LU-SEYY-FQ
Dead Bus 120V 40/65Hz 240V 40/65Hz 480V 40/65Hz	SLOW FAST SLOW FAST SLOW FAST	077-14DU-PQYY-FQ 077-14DU-RRYY-FQ 077-14DU-SEYY-FQ

For connection diagrams, see Fig. 9 on page 58.

In the 0.77-14G and 0.77-14H models, the generator voltage is free to track the bus voltage (+ the voltage difference preset) over the input voltage range. In the 077-14L and 077-14D models, the generator voltage is to match the nominal input (bus) voltage specified (within the voltage difference preset)



AC Synchrocheck Relay and LED 360° Synchroscope



DC Transducer Indicator



AC Watt/Watt Hour Meter

DC Transducer Indicators

Product Codes

Rating	Scaling*	4 1/2" square flange		8 3/4" square flange
		Standard case catalogue no.	Sealed case hi-shock catalogue no.	Standard case catalogue no.
Watts 1mA	To suit	•/+077-055A-FA**	078-055J-FA**	•079-055A-FA**
VARs 1mA	To suit	•/+077-056A-FA**	078-056J-FA**	•079-056A-FA**
Frequency 1mA	To suit	•/+077-053A-FA**	078-053J-FA**	•079-053A-FA**
Power factor 1mA	To suit	•/+077-054A-FA**	078-054J-FA**	•079-054A-FA**
AC amps 1mA	To suit	•/+077-05AA-FA**	078-05AJ-FA**	•079-05AA-FA**
AC volts 1mA	To suit	•/+077-05VA-LT**	078-05VJ-LT**	•079-05VA-LT**
Speed 1mA	To suit	•/+077-052A-FA**	078-052J-FA**	•079-052A-FA**
VA 1mA	To suit	•/+077-057A-FA**	078-057J-FA**	•079-057A-FA**

For use with the following transducers:-
watts, VARs, frequency, power factor,
AC amperes, AC volts and temperature

* Case types 077/078/079 use 10-32 UNF terminals. For M5 screw clamp terminals, use case type 075

** Specify scale. Input: 1mA DC for 4/20mA change "FA" to "HG"

AC Watt and Watt Hour Meters

Moving coil indication gives instantaneous watt reading. An impulse counter driven by self-contained circuitry gives the watt hour indication.

Product Codes – Transducer Driven (Accuracy ±1%)

Externally powered meter with internal linear integrator and six digit impulse counter.

Rating	Scaling*	4 1/2" square flange		8 3/4" square flange
		Standard case catalogue no.	Sealed case hi-shock catalogue no.	Standard case catalogue no.
120V, 240V 1mA	To suit	077-KHAU-FA**	078-KHAJ-FA**	-
50/60Hz 4-20mA		077-KHAU-HG**	078-KHAJ-HG**	-

For connection diagrams, see Fig. 19 on page 59

Product Codes – Self Contained - (Accuracy Instantaneous 1%)

Kilowatt hour 0.5% of pulse rate/hour.

Single Element, Transformer Rated 50/60Hz, Hi-Q Taut Band with Integral Transducer

Measured system	Scales	4 1/2" square flange		8 3/4" square flange
		Standard case catalogue no.	Sealed case hi-shock catalogue no.	Standard case catalogue no.
Phases Wires Amperes 2 VA max. burden Volts 1 VA max. burden				
1 2 5 120	To suit	077-KHBU-QQ**	078-KHBJ-QQ**	-

For connection diagrams, see Fig. 21 on page 60.

2-Element, Transformer Rated 50/60Hz, Hi-Q Taut Band with Integral Transducer

3 3 5 120	To suit	077-KHEU-QQ**	078-KHEJ-QQ**	-
3 3 5 208	To suit	077-KHEU-QR**	078-KHEJ-QR**	-

For connection diagrams, see Fig. 25 on page 60.

2 1/2-Element, Transformer Rated 50/60Hz, Hi-Q Taut Band with Integral Transducer

3 4 5 69	To suit	077-KHGU-QL**	078-KHGG-QL**	-
3 4 5 120	To suit	077-KHGU-QQ**	078-KHGG-QQ**	-
3 4 5 277	To suit	077-KHGU-QY**	078-KHGG-QY**	-

For connection diagrams, see Fig. 28 on page 60.

** Specify pulse rate and external power supply.

• UL approved file no. E203000

LED Digital / Analogue Combination

Crompton model 077-DI features a combination of the traditional 250° 4½" switchboard indicator with the benefits of wide angle visibility plus trend indication. This rugged shock and vibration resistant taut band design provides precision accuracy and instantaneous reading via the bright in-dial mounted 3½" digit LED display.

Description

Model 077-DI digital analogue indicators are ideal for all applications where moving pointer instruments are preferable to indicate trend with the simultaneous display of a high visibility precision LED readout for increased user interface.

Packaged in a weather resistant case, the 077-DI is interchangeable with other analogue and digital instruments designed to directly mount in to a standard ANSI-C39. 4½" switchboard cut-out.

Available in side, center, or off-set zero versions, the 077-DI can accept AC current, voltage, frequency, watts, VAR and phase angle or DC current and voltage direct inputs as well as a wide range of transducer outputs, making it suitable for a variety of other applications including low-load current, temperature, speed, watt/VARS, percent and level.

Specifications

Inputs:	DC Voltage: 20mV-600V (1MΩ input impedance as standard) DC Current: 1mA-1A, 4 to 20mA (Voltage drop 200mV nominal). External shunt operation (50mV and 100mV). AC Voltage: 200mV-600V (1 kΩ / volt) AC Current: 1mA-999mA (Using internal shunt, voltage drop 200mV nominal). 1A, 2A, 5A and 10A using internal current transformer.
Common mode rejection:	=>80dB @ 50/60Hz
Overload:	Voltage: x 1.2 continuous. x1.5 for 10 seconds. Current using internal CT: x 1.2 continuous. x 10 for 10 seconds.
External power requirement:	Standard: 120 and 240V ±15%. Optional: 480V ±15% AC 40-60Hz
Burden:	3VA @ 60Hz
DC:	Standard: 12, 24, 48, 110 and 125V ±15%
Display analogue:	long-scale moving coil. 250° deflection. Scale length 6.8inches. Response time less than 2.5 seconds.
Display options:	Center or offset zero. Scale plate in colours other than white. Coloured lines or segments on scale. Slower response time.
Digital display:	3½ digit red LED. 7 segment (7.6mm, 0.3" high). Right hand decimal points. Polarity indication: positive / none. Negative / horizontal bar " - ". Update time (standard): 1 per second
Accuracy – analogue:	DC and AC ±1% of FSD (calibrated at 25°C)
Accuracy – digital:	DC: ±0.05% of reading ±1 count ±100ppm of reading / °C. (Maximum). AC current: 0-1 Amp ±0.1% reading ±3 counts ±150ppm of reading / °C. AC current: 0-10 amps ±0.1% reading ±10 counts ±150ppm of reading / °C (maximum) AC voltage: ±0.1% of reading ±3 counts ±150ppm of reading / °C. (maximum) Zero ±1 count ±0.2 counts/°C (maximum), DC offset scale only. Warm-up time: 1 minute
Long term stability:	±2 counts
Calibration check:	Recommended 12 monthly intervals
Enclosure code:	IP54 (optional IP55 using panel gasket)
Operational temperature:	0 to 60°C (32° to 140°F).
Storage temperature:	-20 to 60°C (-4° to 140°F)
Humidity:	Up to 90% relative @ 55°C. Tests to BS2011 part 2DA.
Isolation test voltage:	2kV RMS 60Hz for 1 minute
Interference rejection:	To IEEE STD472, ANSI C37 90A, SEN 361503, IEC 255-4
Approvals:	EMC and LVD UL approved file no. E203000



Features

- Rugged shock and vibration resistant taut band design
- High accuracy LED display
- Wide selection of AC and DC inputs
- Maximum trend indication visibility
- Input isolation
- External decimal point selection option
- Interchangeable with 4½" switchboard meters

Benefits

- Cost effective
- Meets all the requirements of ANSI-C39.1 (1981)
- IP54 (NEMA 3) protection.
- Optional IP55 (NEMA 4) gasket
- Bump, shock and vibration proof
- Customised options and features

Applications

- Switchgear
- Distribution systems
- Generator sets
- Control panels
- Energy management
- Building management
- Utility power monitoring
- Process control
- Motor control

Approvals

UL approved file no. E203000



AC Voltmeter

LED Digital/Analogue Combination

Product Codes – AC Voltmeters – Direct Reading (40/2000Hz)***

(Digital accuracy $\pm 0.1\%$ ± 3 counts, analogue accuracy $\pm 1\%$)

Rating	Scaling*	Catalogue no.
200mV	0-200mV	077-DIWA-KAKA-C6-**
250mV	0-250mV	077-DIWA-KDKD-C6-**
500mV	0-500mV	077-DIWA-KMKM-C6-**
1V	0-1V	077-DIWA-LALA-C6-**
5V	0-5V	077-DIWA-LSLS-C6-**
10V	0-10V	077-DIWA-MTMT-C6-**
15V	0-15V	077-DIWA-NDND-C6-**
30V	0-30V	077-DIWA-NLNL-C6-**
150V	0-150V	077-DIWA-PZPZ-C6-**
250V	0-250V	077-DIWA-RSRS-C6-**
300V	0-300V	077-DIWA-RXRX-C6-**
500V	0-500V	077-DIWA-SFSF-C6-**
600V	0-600V	077-DIWA-SJSJ-C6-**

For connection diagrams, see Fig. 46 on page 62.

Product Codes – AC Voltmeters Transformer Rated (40/2000Hz)***

Rating	Scaling*	Catalogue no.
150V	0-300V	077-DIWA-PZRX-C6-**
150V	0-600V	077-DIWA-PZSJ-C6-**
150V	0-750V	077-DIWA-PZSM-C6-**
150V	0-3000V	077-DIWA-PZUA-C6-**
143V	0-5000V	077-DIWA-PTUJ-C6-**
150V	0-5250V	077-DIWA-PZUL-C6-**
150V	0-6000V	077-DIWA-PZUP-C6-**
150V	0-9000V	077-DIWA-PZUY-C6-**
150V	0-15KV	077-DIWA-PZWC-C6-**
150V	0-18KV	077-DIWA-PZWD-C6-**
150V	0-45KV	077-DIWA-PZWJ-C6-**
150V	0-60KV	077-DIWA-PZWL-C6-**

For connection diagrams, see Fig. 45 on page 62.

Product Codes – AC Ammeters – Direct Reading (40/2000Hz)***

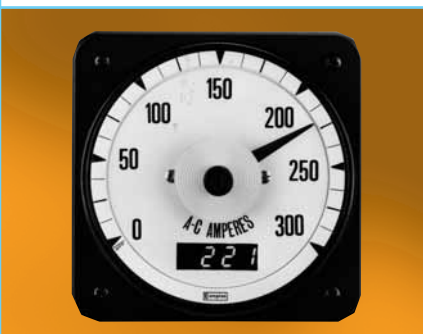

AC Ammeter

Rating	Scaling*	Catalogue no.
1A	0-1A	077-DIBA-LALA-C6-**
1.5A	0-1.5A	077-DIBA-LCLC-C6-**
2A	0-2A	077-DIBA-LELE-C6-**
3A	0-3A	077-DIBA-LJLJ-C6-**
5A	0-5A	077-DIBA-LSLS-C6-**
8A	0-8A	077-DIBA-MJMJ-C6-**
10A	0-10A	077-DIBA-MTMT-C6-**

For connection diagrams, see Fig. 45 on page 62.

Product Codes – Power Supply

MU - 12V DC	PQ - 120V AC
Z2 - 130V DC	PR - 120V DC
BD - 24V DC	RR - 240V AC
PO - 115V AC	PS - 125V DC
NR - 48V DC	

* Other scalings available.

** Specify power supply voltage according to Power Supply Codes table.

*** Case types 077/078/079 use 10-32 UNF terminals.
For M5 screw clamp terminals, use case type 075.

LED Digital/Analogue Combination

Product Codes – AC Ammeters Transformer Rated (40/2000Hz)

(Digital accuracy $\pm 0.1\%$ ± 1 counts, analogue accuracy $\pm 1\%$)

Rating	Scaling*	Catalogue no.
5A	0-15A	077-DIBA-LSND-C6-**
5A	0-20A	077-DIBA-LSNG-C6-**
5A	0-25A	077-DIBA-LSNJ-C6-**
5A	0-30A	077-DIBA-LSNL-C6-**
5A	0-40A	077-DIBA-LSNP-C6-**
5A	0-50A	077-DIBA-LSNT-C6-**
5A	0-60A	077-DIBA-LSNW-C6-**
5A	0-75A	077-DIBA-LSPB-C6-**
5A	0-80A	077-DIBA-LSPD-C6-**
5A	0-100A	077-DIBA-LSPK-C6-**
5A	0-150A	077-DIBA-LSPZ-C6-**
5A	0-200A	077-DIBA-LSRL-C6-**
5A	0-250A	077-DIBA-LSRS-C6-**
5A	0-300A	077-DIBA-LSRX-C6-**
5A	0-400A	077-DIBA-LSSC-C6-**
5A	0-500A	077-DIBA-LSSF-C6-**
5A	0-600A	077-DIBA-LSSJ-C6-**
5A	0-750A	077-DIBA-LSSM-C6-**
5A	0-800A	077-DIBA-LSSN-C6-**
5A	0-1000A	077-DIBA-LSSS-C6-**
5A	0-1200A	077-DIBA-LSSU-C6-**
5A	0-1500A	077-DIBA-LSTC-C6-**
5A	0-1600A	077-DIBA-LSTE-C6-**

For connection diagrams, see Fig. 45 on page 62.

Product Codes – AC Frequency Meters

Self contained meter with a 110/130 voltage rating and a moving coil indicator integral transducer

Centre frequency	Accuracy	Scaling*	Catalogue no.
50Hz	± 0.15	45-55Hz	077-DZLA-PNAG-AG
50Hz	± 0.15	46-54Hz	077-DZLA-PNAH-AH
55Hz	± 0.25	45-65Hz	077-DZLA-PNAJ-AJ
60Hz	± 0.25	50-70Hz	077-DZLA-PNAL-AL
60Hz	± 0.15	55-65Hz	077-DZLA-PNAN-AN
60Hz	± 0.15	56-64Hz	077-DZLA-PNAO-AO
60Hz	± 0.08	58-62Hz	077-DZLA-PNAT-AT
400Hz	± 1.3	350-450Hz	077-DZLA-PNBH-BH
400Hz	± 1.25	360-440Hz	077-DZLA-PNBI-BI
400Hz	± 0.08	380-420Hz	077-DZLA-PNBK-BK

For connection diagrams, see Fig. 44 on page 62.

Product Codes – Power Supply

MU - 12V DC	PQ - 120V AC
Z2 - 130V DC	PR - 120V DC
BD - 24V DC	RR - 240V AC
PO - 115V AC	PS - 125V DC
NR - 48V DC	

- For alternative voltage rating 200/250V, specify RN instead of PN.
- For alternative voltage rating 380/480V, specify SE instead of PN.
- * Other scales are available.
- ** Specify power supply voltage, according to Power Supply Codes table.



AC Ammeter



AC Frequency Meter



DC Voltmeter

LED Digital/Analogue Combination

Product Codes – DC Voltmeters – Direct Reading

(Digital accuracy $\pm 0.5\%$ ± 1 counts, analogue accuracy $\pm 1\%$)

Rating	Scaling*	Catalogue no.
200mV	0-200mV	077-DIVA-KAKA-**
250mV	0-250mV	077-DIVA-KDKD-**
500mV	0-500mV	077-DIVA-KMKM-**
1V	0-1V	077-DIVA-LALA-**
5V	0-5V	077-DIVA-LSLS-**
10V	0-10V	077-DIVA-MTMT-**
15V	0-15V	077-DIVA-NDND-**
30V	0-30V	077-DIVA-NLNL-**
50V	0-50V	077-DIVA-NTNT-**
75V	0-75V	077-DIVA-PBPB-**
80V	0-80V	077-DIVA-PDPD-**
150V	0-150V	077-DIVA-PZPZ-**
300V	0-300V	077-DIVA-RXR-**
400V	0-400V	077-DIVA-SCSC-**
500V	0-500V	077-DIVA-SFSF-**
600V	0-600V	077-DIVA-SJSJ-**
150-0-150V	150-0-150V	077-DINA-RXR-**
300-0-300V	300-0-300V	077-DINA-SJSJ-**
600-0-600V	600-0-600V	077-DINA-SUSU-**

For connection diagrams, see Fig. 45 on page 62.

LED Digital/Analogue Combination

Product Codes – DC Ammeters – Shunt Rated

(Digital accuracy $\pm 0.5\%$ ± 1 counts, analogue accuracy $\pm 1\%$)

Rating	Scaling*	Catalogue no.
50mV-4mA	Scaled to suit	077-DIAA-EY
50-0-50mV-2-0-2mA		077-DICA-GB
100-0-100mV	standard	077-DICA-GM
100-0-100mV-2-0-2mA	shunt ratings	077-DICA-FM

For connection diagrams, see Fig. 45 on page 62.

Product Codes – DC Ammeters – Suppressed Zero

(Digital accuracy $\pm 0.5\%$ ± 1 counts, analogue accuracy $\pm 1\%$)

Rating	Scaling*	Catalogue no.
1-5mA	To suit requirements	077-DIAA-GM
4-20mA		077-DIAA-HG
10-50mA		077-DIAA-HZ

For connection diagrams, see Fig. 45 on page 62.

Product Codes – DC Ammeters – Direct Reading

(Digital accuracy $\pm 0.5\%$ ± 1 counts, analogue accuracy $\pm 1\%$)

Rating	Scaling*	Catalogue no.
1mA	0-1mA	077-DIAA-FAFA-**
2mA	0-2mA	077-DIAA-FGFG-**
5mA	0-5mA	077-DIAA-FXFX-**
10mA	0-10mA	077-DIAA-GZGZ-**
20mA	0-20mA	077-DIAA-HFHF-**
30mA	0-30mA	077-DIAA-HMHM-**
50mA	0-50mA	077-DIAA-HYHY-**
100mA	0-100mA	077-DIAA-JRJR-**
200mA	0-200mA	077-DIAA-KAKA-**
300mA	0-300mA	077-DIAA-KGKG-**
500mA	0-500mA	077-DIAA-KMKM-**
800mA	0-800mA	077-DIAA-KWKW-**
1A	0-1A	077-DIAA-LALA-**

For connection diagrams, see Fig. 45 on page 62.

Product Codes – Power Supply

MU - 12V DC	PQ - 120V AC
Z2 - 130V DC	PR - 120V DC
BD - 24V DC	RR - 240V AC
PO - 115V AC	PS - 125V DC
NR - 48V DC	

* Other scales are available.

** Speedy power supply voltage according to Power Supply Codes table.



DC Ammeter



AC Wattmeter

LED Digital/Analogue Combination

Product Codes – AC Wattmeters, Single Phase 50/60Hz (Accuracy $\pm 1\%$)

Measured system		Scales	4½" square flange standard case catalogue no.	
Phases	Wires			
Amperes	1 VA max. burden			
Volts	1 VA max. burden			
1	2	5A 120V	To suit	077-DW5A-QQ**-C6
1	2	5A 240V	To suit	077-DW5A-QS**-C6

For connection diagram, see Fig. 37 on page 61.

Product Codes – AC Wattmeters, 2 Element, Transformer Rated, 50/60Hz, Integral Transducer (Accuracy 1.0%)

3	3	5A 120V	To suit	077-DW8A-QQ**-C6
3	3	5A 240V	To suit	077-DW8A-QR**-C6

For connection diagram, see Fig. 38 on page 62.

Product Codes – AC Wattmeters, 3 Element, Transformer Rated, 50/60Hz, Integral Transducer

3	4	5A 69V	To suit	077-DW9A-QL**-C6
3	4	5A 120V	To suit	077-DW9A-QQ**-C6

For connection diagram, see Fig. 39 on page 62.



AC VArmeter

Product Codes – AC VArmeters, 2 Element, Transformer Rated, 50/60Hz, Integral Transducer

3	3	5A 120V	To suit	077-DXLA-QQ**-C6
3	3	5A 208V	To suit	077-DXLA-QR**-C6

For connection diagram, see Fig. 40 on page 62.

Product Codes – AC VArmeters, 2 Element, Transformer Rated, 50/60Hz, Integral Transducer

3	4	5A 120V	To suit	077-DXUA-QQ**-C6
3	4	5A 208V	To suit	077-DXUA-QR**-C6

For connection diagram, see Fig. 41 on page 62.



Power Factor/Phase Angle Meter

Product Codes – Power Factor and Phase Angle Meters. Accuracy 1.0% (Balanced Loads), Self Contained, 60Hz, Integral Transducer

1	2	5A 120V	0.5-1-0.5 LAG/LEAD and 60/0/60 DEG	077-DP5A-QQAD-C6
1	2	5A 240V	0.5-1-0.5 LAG/LEAD and 60/0/60 DEG	077-DP5A-QSAD-C6
3	3/4	5A 120V	0.5-1-0.5 LAG/LEAD and 60/0/60 DEG	077-DP7A-QQAD-C6
3	3/4	5A 208V	0.5-1-0.5 LAG/LEAD and 60/0/60 DEG	077-DP7A-QRAD-C6
3	3/4	5A 240V	0.5-1-0.5 LAG/LEAD and 60/0/60 DEG	077-DP7A-QSAD-C6
3	3/4	5A 480V	0.5-1-0.5 LAG/LEAD and 60/0/60 DEG	077-DP7A-QTAD-C6

For connection diagram, see Fig. 42 and 43 on page 62.

** Specify CT (Current Transformer) and VT (Voltage Transformer) ratios if used, and preferred scale at time of ordering.

LED Digital/Analogue Combination

Scale – Options

Options	Option code
1. Blank, uncalibrated dial (zero and full scale marks in pencil).	SA
2. Red or coloured line or mark (specify position).	SR
3. Coloured zones or segments (specify limits and colour(s)).	SZ
4. Non-standard caption (other than listed below).	SD
5. Black dial with white figures and pointer.	SB
6. Customer/user logo imprinted on dial.	SM
7. Finely divided scale.	-
8. Standard rating, single unlisted scale	-



Calibration – Options

Options	Option code
10. Zero-center scale. Not available for AC ammeters and voltmeters	-
11. Offset-zero scale wattmeters, VARmeters, DC ammeters and voltmeters.	-
12. Calibration to customer specification including special caption.	-
13. Calibration other than vertical, specify required angle from vertical.	CM
14. Non-listed ratings.	-
15. Temperature calibration, other than 23°C ambient.	CT
16. a) Calibration at 400Hz. b) Calibration to other specific frequencies between 25 and 500Hz.	C4
17. Potentiometer, externally mounted $\pm 10\%$ range adjustment.	-
18. Suppressed zero other than listed. DC only.	RA
19. Heavily damped movement.	PD

Construction – Options

Options	Option code
20. Anti-glare window.	BR
21. Internal illumination. Specify 6, 12, 24 or 36V DC	EL
22. *Neoprene™ polychloroprene panel basket.	MG
23. Red manual set pointer.	ER
25. Coloured bezel.	FA
26. Hermetically sealed case.	-

*Neoprene is a Trademark of E.I. DuPont de Nemours.



Connection Diagrams

Fig. 1 Model 077-12P
Phase Sequence Indicator 3-Phase
3- or 4-Wire systems

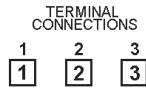

Fig. 2 Model 077-137
360° Dynamometer Power Factor
Indicator Single Phase

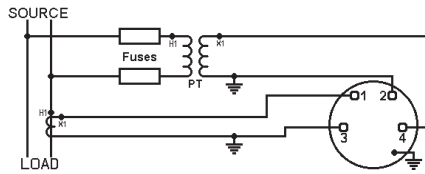

Fig. 3 Model 077-131
360° Dynamometer Power Factor
Indicator 3-Phase 3- or 4-Wire Balanced
Load (3 Currents 1 Voltage)

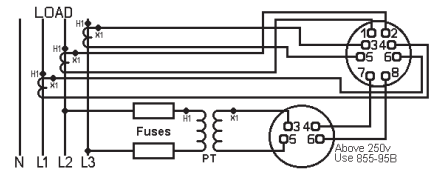

Fig. 4 Models 077-132, 078-132J
360° Dynamometer Power Factor
Indicator 3-Phase 3- or 4-Wire Balanced
Load (1 Current 3 Voltages)

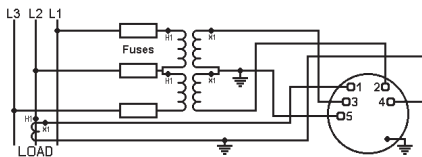

Fig. 5 Model 078-132B
360° Dynamometer Power Factor
Indicator 3-Phase 3- or 4-Wire
Balanced Load (1 Current 3 Voltages)

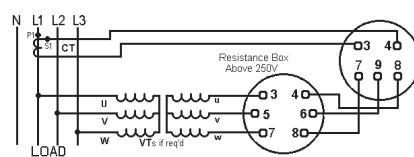

Fig. 6 Models 077-136, 077-136A,
078-136J
360° Dynamometer Power Factor
Indicator 3-Phase 3- or 4-Wire
Unbalanced Load

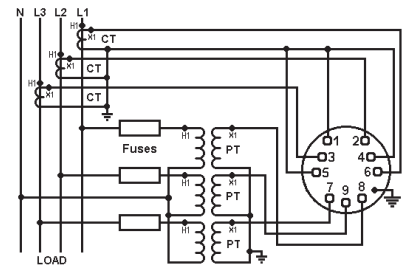

Fig. 7 Model 078-136B
360° Dynamometer Power Factor
Indicator 3-Phase 3- or 4-Wire
Unbalanced Load

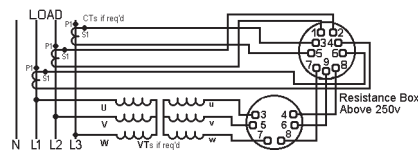

Fig. 8 Models 077-14A
360° LED Synchroscope

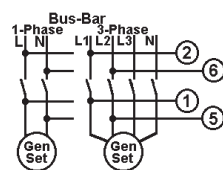
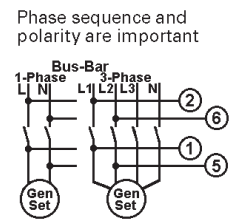

Fig. 9 Models 077-14D, 077-14G,
077-14H, 077-14L
360° LED Synchroscope and
Synchro Check Relay



Connection Diagrams

Fig. 10 Models 077-144, 077-145
077-146, 077-147, 078-144J, 078-145J
078-146J, 078-147J, 079-144, 079-145
079-146
360° Dynamometer Synchroscope

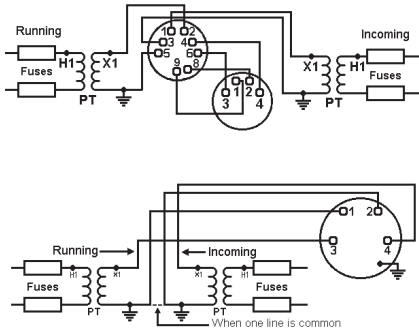

Fig. 11 Models 078-144B, 078-145B
078-146B, 078-147B
360° Dynamometer Synchroscope

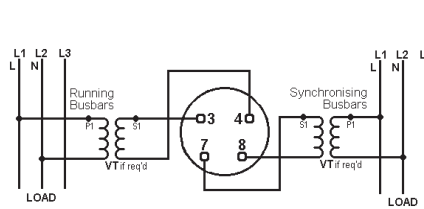

Fig. 12 Model 077-TFU
Power Factor Meter 3-Phase 3-Wire
Unbalanced Load

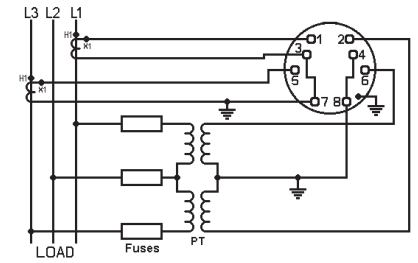

Fig. 13 Models 077-425, 078-425J
079-425
Electronic Phase Angle Meter
Single Phase

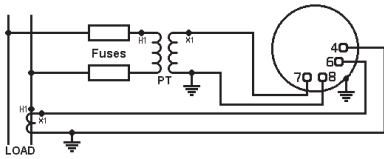

Fig. 14 Model 078-425B
Electronic Phase Angle Meter
Single Phase

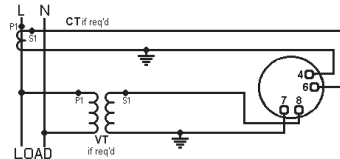

Fig. 15 Models 075-427, 077-427
078-427J, 079-427
Electronic Phase Angle Meter 3-phase
3- or 4-wire Balanced Load

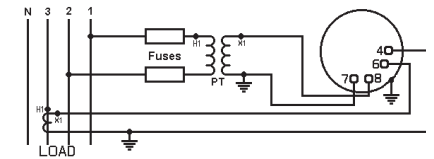

Fig. 16 Model 078-427B
Electronic Phase Angle Meter 3-Phase
3- or 4-Wire Balanced Load

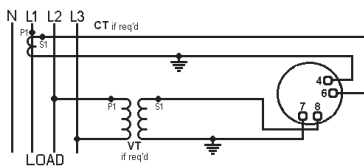
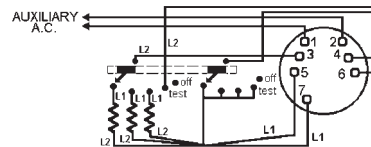

Fig. 17 Models 077-45R, 078-45R
Temperature Indicator for Resistance
Temperature Detector (RTD)



NOTE
All L1 Leads must be within 0.02 ohms of the same resistance
L1 Leads should not exceed 3 ohms each
L2 Leads should not exceed 0.02 ohms each

Fig. 18 Model 077-45T
Temperature Indicator for
Thermocouple Detector

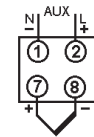
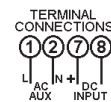

Fig. 19 Models 077-KHA, 078-KHA
AC Kilowatts/Kilowatthours
(Transducer) Indicator



Connection Diagrams

Fig. 20 Model 077-45P
Tap Position Indicator

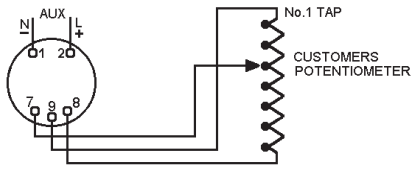

Fig. 21 Models 077-215, 077-KHB
078-215J, 078-KHBJ, 079-215
Wattmeter Single Phase

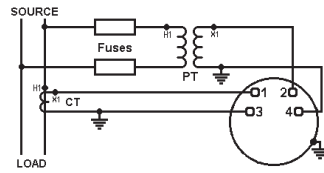

Fig. 22 Model 078-215B, 078-KHBB
Wattmeter Single Phase

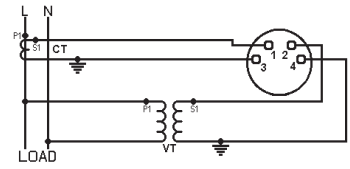

Fig. 23 Models 077-216, 078-216J
Wattmeter 3-Phase 3-Wire
Balanced Load

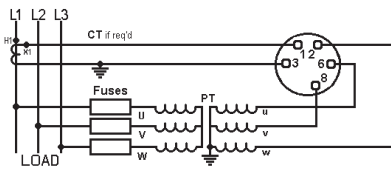

Fig. 24 Model 078-216B
Wattmeter 3-Phase 3-Wire
Balanced Load

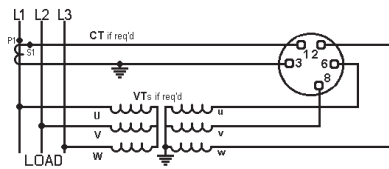

Fig. 25 Models 077-218, 077-KHE
078-218J, 078-KHEJ, 079-218
Wattmeter 3-Phase 3-Wire
Unbalanced Load

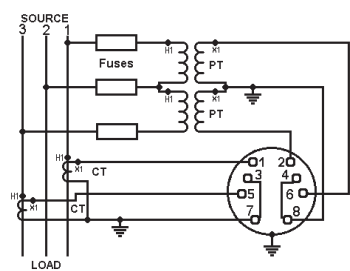

Fig. 26 Models 078-218B, 078-KHEB
Wattmeter 3-Phase 3-Wire
Unbalanced Load

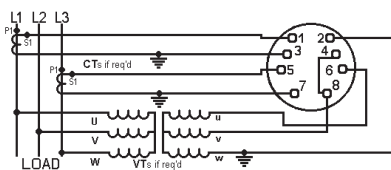

Fig. 27 Model 077-21D
Wattmeter 3-Phase 4-Wire
Balanced Load

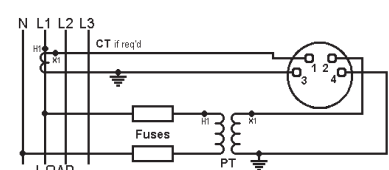
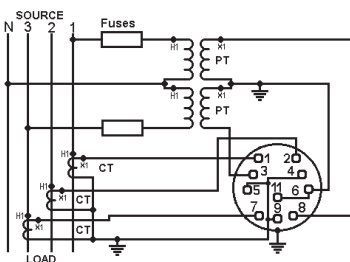

Fig. 28 Models 077-219, 077-KHG
078-219J, 078-KHGJ, 079-219
Wattmeter 3-Phase 4-Wire
Unbalanced Load



Connection Diagrams

Fig. 29 Models 078-219B, 078-KHGB
Wattmeter 3-Phase 4-Wire
Unbalanced Load

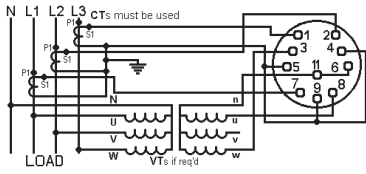

Fig. 30 Models 077-21B
Wattmeter 3-Phase 3-Wire Balanced Load
2 Reverse Connected CTs

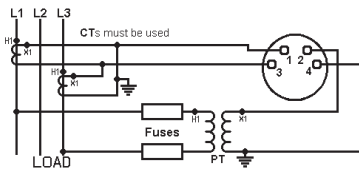

Fig. 31 Model 077-21F
Wattmeter 3-Phase 4-Wire Unbalanced Load
Delta Connected CTs

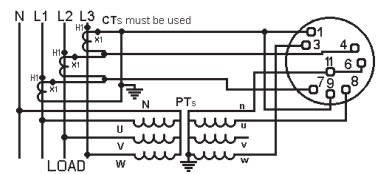

Fig. 32 Models 077-31L, 078-31LJ
VArmeter 3-Phase 3-Wire
Unbalanced Load

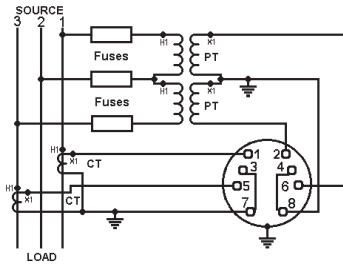

Fig. 33 Models 077-315
VArmeter 3-Phase 3- or 4-Wire
Balanced Load

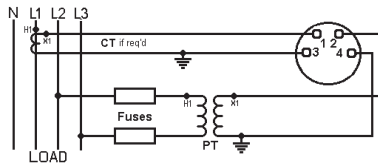

Fig. 34 Model 077-319
VArmeter 3-Phase 4-Wire
Unbalanced Load

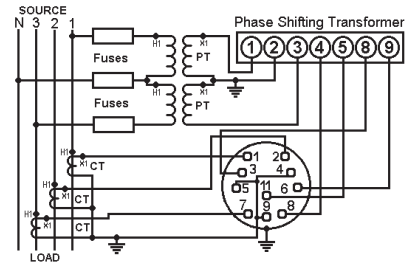

Fig. 35 Models 077-31U, 077-KXG
078-31U, 079-31U
VArmeter 3-Phase 4-Wire
Unbalanced Load

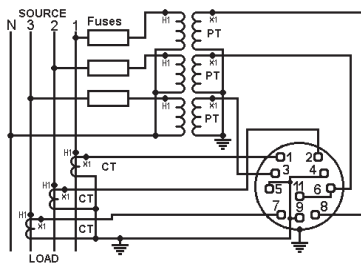

Fig. 36 Model 077-31F
VArmeter 3-Phase 4-Wire Unbalanced Load
Delta Connected CTs

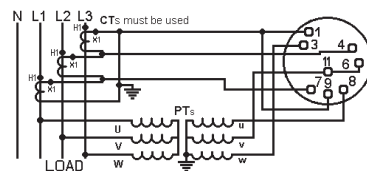
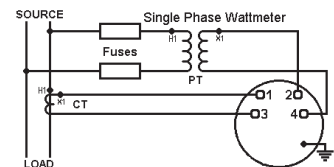

Fig. 37 Model 077-DW5
LED Digital/Analogue Wattmeter
Single Phase



Connection Diagrams

Fig. 38 Model 077-DW8
LED Digital/Analogue Wattmeter 3-Phase
3-Wire Unbalanced Load

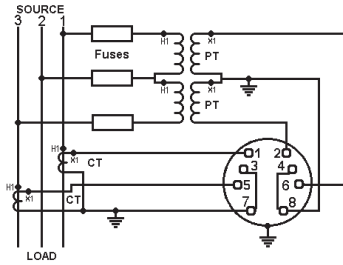

Fig. 39 Model 077-DW9
LED Digital/Analogue Wattmeter
3-Phase 4-Wire Unbalanced Load

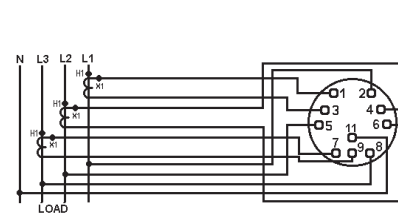

Fig. 40 Model 077-DXL
LED Digital/Analogue VArmeter 3-Phase
3-Wire Unbalanced Load

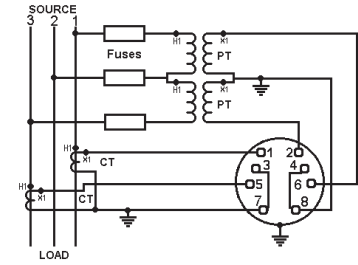

Fig. 41 Model 077-DXU
LED Digital/Analogue VArmeter 3-Phase
4-Wire Unbalanced Load

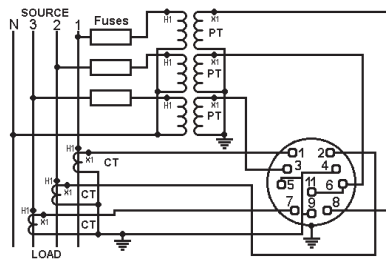

Fig. 42 Model 077-DP5
LED Digital/Analogue Phase Angle Meter
Single Phase

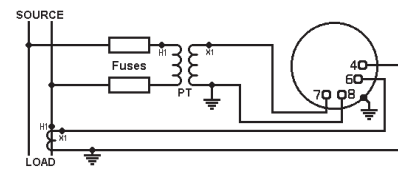

Fig. 43 Model 077-DP7
LED Digital/Analogue Phase Angle Meter
3-Phase 3- or 4-Wire Balanced Load

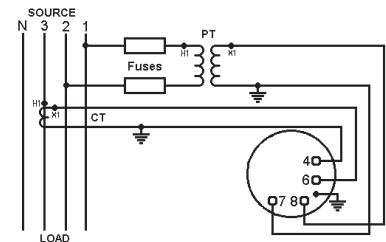

Fig. 44 Model 077-DZL
LED Digital/Analogue Frequency Meter

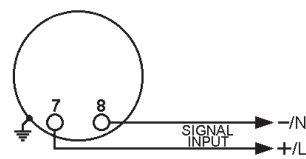

Fig. 45 Models 077-DI2, 077-DIA
077-DIB, 077-DIC, 077-DIN, 077-DIT
077-DIV, 077-DIW
LED Digital/Analogue Meter

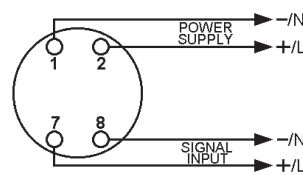
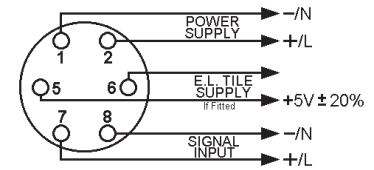

Fig. 46 Models 077-DA2, 077-DAA
077-DAB, 077-DAK, 077-DAT
077-DAV, 077-DAW
LCD Digital/Analogue Meter



549 Series Panel Meters

Compact panel meters designed to fit standard 17/32" switch knock-outs. This range includes high accuracy AC and DC ammeters and voltmeters, elapsed time meters and impulse counters.

Specifications

Enclosure code:	IP42 (IEC 529)
System frequencies:	AC Ammeters: 50, 60 or 400Hz AC Voltmeters: 50 or 60Hz Elapsed Time Meter: 50 or 60Hz
System voltage:	Elapsed Time Meter: 110/130V AC, 200/250V AC, 6 or 12V DC
Input ratings available:	AC Ammeter: 50mA-5A (self contained) extendible to 50A with external wound primary CT AC Voltmeter: 30-600V DC Ammeter: 100µA-20mA DC Voltmeter: 50mV-600V
Scale:	Angle: 90°. Length: 1 inch (26mm)
Operating temperature:	-10°C to 55°C (15 to 130°F).
Bezel window:	Toughened glass
Fixing on panel:	Simple clamp fixing
Approvals:	EMC and LVD, ABS (American Bureau of Shipping)

Dimensions

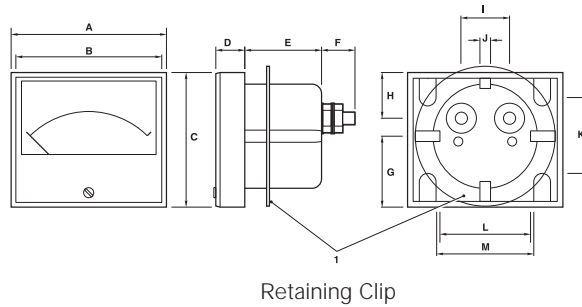

	A	B	C	D	E*	F	G	H	I	J	K	L	M
in.	1.81		1.56	0.34	0.91	0.51	0.85	0.24	0.51	0.16	1.08	1.08	1.18
mm	46		39.6	8.6	23	13	21.6	6.1	13	4	27.5	27.5	30

Elapsed Time Meters

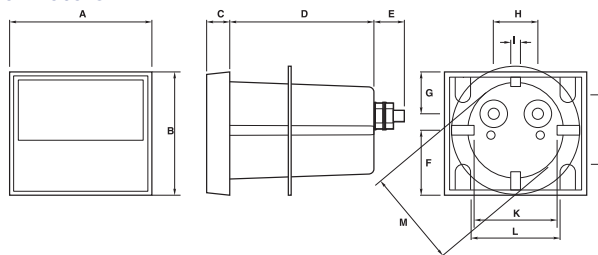

	A	B	C	D	E	F	G	H	I	J	K	L	M
in.	1.84	1.59	0.34	1.75	0.51	0.86	0.24	0.51	0.16	1.08	1.08	1.18	1.18
mm	46.8	40.4	8.6	44.3	13	21.9	6	13	4.1	27.5	27.5	30	30

Panel Cut-Out

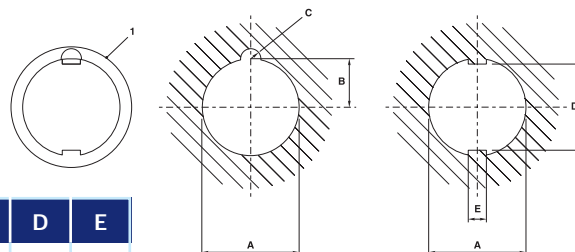

	A	B	C	D	E
in.	1.2	0.57	0.25	1.09	0.15
mm	30.5	14.5	6.4	27.8	3.9



Features

- Compact size
- Fits standard 17/32 inch switch knock-outs
- Toughened glass window
- AC and DC ammeters and voltmeters available
- "Hours run" and impulse counters available

Benefits

- Simple clamp fixing
- Easy installation on replacement
- Panel space saving
- Customised options and features

Applications

- Switchgear
- Distribution systems
- Generator sets
- Control panels
- Energy management
- Building management
- Utility power monitoring
- Process control
- Motor control

Approvals

ABS (American Bureau of Shipping) approved file no. 93-LD 17806-X



AC Ammeter

AC Ammeter

Product Codes – Self Contained 50mA Rating For Use With Separately Wound Primary Current Transformer

Input	Scaling	Catalogue no.
50mA	0-1A	549-78AA-HXLA
50mA	0-5A	549-78AA-HXLS
50mA	0-7.5A	549-78AA-HXMF
50mA	0-10A	549-78AA-HXMT
50mA	0-15A	549-78AA-HXND
50mA	0-20A	549-78AA-HXNG
50mA	0-30A	549-78AA-HXNL
50mA	0-40A	549-78AA-HXNP
50mA	0-50A	549-78AA-HXNT

Product Codes – For Use With External Current Transformers

Other Scales Available

Input	Scaling	Catalogue no.
5A	0-50A	549-78AA-LSNT
5A	0-60A	549-78AA-LSNW
5A	0-75A	549-78AA-LSPB
5A	0-80A	549-78AA-LSPD
5A	0-100A	549-78AA-LSPK
5A	0-150A	549-78AA-LSPZ
5A	0-200A	549-78AA-LSRL
5A	0-300A	549-78AA-LSRX
5A	0-400A	549-78AA-LSSC
5A	0-500A	549-78AA-LSSF
5A	0-600A	549-78AA-LSSJ
5A	0-800A	549-78AA-LSSN
5A	0-1000A	549-78AA-LSSS
5A	0-1200A	549-78AA-LSSU
5A	0-1500A	549-78AA-LSTC
5A	0-1600A	549-78AA-LSTE
5A	0-2000A	549-78AA-LSTM

AC Voltmeter

Product Codes – Other Scales Available

Input	Scaling	Catalogue no.
150V	0-150V	549-78VA-PZPZ
150V	0-300V	549-78VA-PZRX
150V	0-600V	549-78VA-PZSJ
150V	0-750V	549-78VA-PZSM



Elapsed Time Meter

Elapsed Time Meter

Product Codes

Input	Scaling	Catalogue no.
110/130V AC, 50Hz	99999.99	549-155A-PNC5-ZH
110/130V AC, 60Hz	99999.99	549-156A-PNC6-ZH
200/250V AC, 50Hz	99999.99	549-155A-RNC5-ZH
200/250V AC, 60Hz	99999.99	549-156A-RNC6-ZH
6V DC, DC	99999.99	549-151A-LWZH
12V DC, DC	99999.99	549-151A-MUZH

Impulse Counters

Product Code

Input	Scaling	Catalogue no.
120V AC, 60Hz	999999	549-257A-PQC6

DC Ammeter

Product Codes – For Use With Current Shunts

Input	Scaling	Catalogue no.
0-50mV	0-5	549-80AA-ECLS
0-50mV	0-10	549-80AA-ECMT
0-50mV	0-15	549-80AA-ECND
0-50mV	0-20	549-80AA-ECNG
0-50mV	0-30	549-80AA-ECNL
0-50mV	0-50	549-80AA-ECNT
0-50mV	0-80	549-80AA-ECPD
0-50mV	0-100	549-80AA-ECPK
0-50mV	0-150	549-80AA-ECPZ
0-50mV	0-200	549-80AA-ECRL
0-50mV	0-250	549-80AA-ECRS
0-50mV	0-300	549-80AA-ECRX
0-50mV	0-400	549-80AA-ECSC
0-50mV	0-500	549-80AA-ECSF
0-50mV	0-600	549-80AA-ECSJ
0-50mV	0-800	549-80AA-ECSN
0-50mV	0-1000	549-80AA-ECSS
0-50mV	0-1200	549-80AA-ECSU
0-50mV	0-1500	549-80AA-ECTC
0-50mV	0-2000	549-80AA-ECTM

Product Codes – Direct Connected

Input	Scaling	Catalogue no.
0-100µA	To suit	549-80AA-DR**
0-1mA	To suit	549-80AA-FA**
0-20mA	To suit	549-80AA-HF**
4-20mA	To suit	549-80AA-HG*

DC Voltmeter

Product Code

Input	Scaling	Catalogue no.
0-50mV to 0-150V	To suit	549-80VA-****

** Specify scale required.

**** Specify input and scale required.

100mV shunt rated DC ammeters are available, replace the code EC with GB.

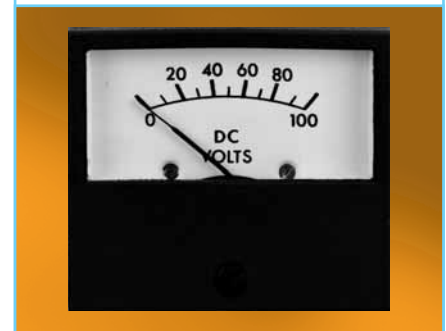

DC Voltmeter



Saxon Indicators

A range of 2 1/2", 3 1/2" and 4 1/2" surface mount panel meters utilising pivot and jewel mechanisms and offering IP54 protection. The range includes iron vane and moving coil AC and DC ammeters and voltmeters, elapsed time and frequency meters designed to perform in demanding environments.

Specifications – Elapsed Time Meter and Frequency Meter

Accuracy:	0.15 = 60Hz, 1.25 = 400Hz, 0.15 = 50Hz, 0.25 = 55Hz
Voltage:	110/130V, 200/250V
Frequency:	50Hz or 60Hz
Burden:	4VA Maximum

Specifications – Moving Iron AC Ammeter and Voltmeter

Accuracy:	±2%
Rating:	Ammeters: 1 - 30A Volts: 10V - 600V
Overload:	Ammeters: x1.2 for 2 hours, x10 for 5 seconds Volts: x1.2 for 2 hours, x2 for 5 seconds
Burden:	Ammeters: 0.5VA Volts: 4.5VA maximum

Specifications – Moving Coil DC Ammeter and Voltmeter

Accuracy:	±2%
Rating:	Ammeters: 100µA - 30A Volts: 50mV - 600V
Operating temp:	-20°C to 60°C (-4°F to 140°F)
Storage temp:	-30°C to 70°C (-22°F to 158°F)

Dimensions

Specify number of fixing studs when ordering 2 1/2" and 3 1/2" meters. 4 1/2" meters are supplied with 4 fixing studs.

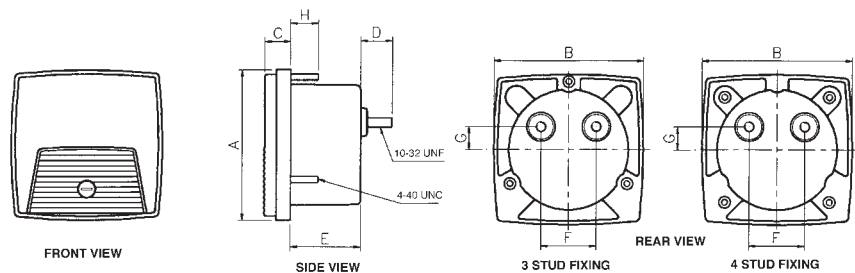

	A	B	C	D	E	F	G	H	J	K	L	M	N	O	P
2 1/2"	68.6	68.6	11.8	14.6	32.0	25.4	10.4	12.7	55.9	31	46.5	26.9	23.9	47.8	23.9
inch	2.70	2.70	0.46	0.57	1.26	1.00	0.41	0.50	2.20	1.22	1.83	1.06	0.94	1.88	0.94
3 1/2"	88.9	88.9	11.8	14.6	36.0	25.4	10.4	12.7	69.9	40.2	60.3	34.8	28.5	57.0	28.5
inch	3.5	3.5	0.46	0.57	1.42	1.00	0.41	0.50	2.75	1.58	2.37	1.37	1.12	2.24	1.12
4 1/2"	112.0	123.2	12.7	16.3	30.5	28.4	0.38	12.7	70.9				51.6	90.4	50.8
inch	4.41	4.85	0.50	0.64	1.20	1.12	0.41	0.50	2.78				2.03	3.56	2.00

Panel cut-out

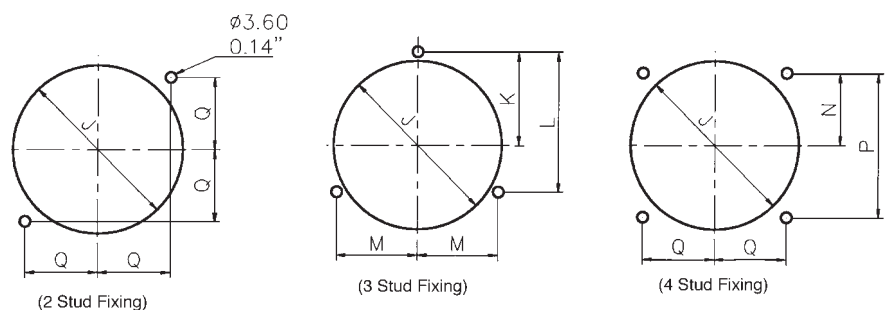

Features

Three compact case sizes
Withstands high levels of shock, vibration, dirt and humidity
Pivot and jewel mechanisms

Benefits

Complies with ANSI C39.1 (IEC 51)
IP54 (NEMA 3) protection
Instruments comply with BSEN61010-1 and meet IEC414 (BS5458)
Pass dielectric test (2600V for 1min)

Applications

Switchgear
Distribution systems
Generator sets
Control panels
Energy management
Building management
Utility power monitoring
Process control
Motor control

Approvals

UL approved file no. E203000

Product Codes – AC Ammeter True RMS Reading (Accuracy ±2% ES)

Rating	Scaling	Catalogue no.
5A	0-5A	(01*)-75AA-LSLS-C6-B*
10A	0-10A	(01*)-75AA-MTMT-C6-B*
15A	0-15A	(01*)-75AA-NDND-C6-B*
20A	0-20A	(01*)-75AA-NGNG-C6-B*
30A	0-30A	(01*)-75AA-NLNL-C6-B*
1A	Transformer rated	(01*)-75AA-LA**-C6-B*
5A	Transformer rated	(01*)-75AA-LS**-C6-B*

Product Codes – AC Voltmeter True RMS Reading (Accuracy ±2% ES)

150V	0-150V	(01*)-75VA-PZPZ-C6-B*
300V	0-300V	(01*)-75VA-RXR X-C6-B*
600V	0-600V	(01*)-75VA-SJSJ-C6-B*
150V	Transformer rated	(01*)-75VA-PZ**-C6-B*

Product Codes – DC Ammeters (Accuracy ±2% ES)

0-1mA	To suit requirements	(01*)-01AA-FA**-B*
0-5mA	0-5mA	(01*)-01AA-FXFX-B*
0-10mA	0-10mA	(01*)-01AA-GZGZ-B*
0-20mA	0-20mA	(01*)-01AA-HFHF-B*
0-50mA	0-50mA	(01*)-01AA-HYHY-B*
0-100mA	0-100mA	(01*)-01AA-JRJR-B*
0-200mA	0-200mA	(01*)-01AA-KAKA-B*
0-500mA	0-500mA	(01*)-01AA-KMKM-B*
0-1A0-1A	(01*)-01AA-LALA-B*	
0-2A0-2A	(01*)-01AA-LELE-B*	
0-5A0-5A	(01*)-01AA-LSLS-B*	
0-10A	0-10A	(01*)-01AA-MTMT-B*
0-50mV	To suit	(01*)-01AA-EC**-B*

Product Codes – Milliammeters Suppressed Zero (Accuracy ±2% ES)

4-20mA	To suit requirements	(01*)-01RA-HG**-B*
		**Specify scale value

Product Codes – DC Voltmeters Sensitivity 1000Ω/Volt (Accuracy ±2% ES)

0-15V	0-15V	(01*)-01VA-NDND-B*
0-30V	0-30V	(01*)-01VA-NLNL-B*
0-50V	0-50V	(01*)-01VA-NTNT-B*
0-150V	0-150V	(01*)-01VA-PZPZ-B*
0-300V	0-300V	(01*)-01VA-RXR X-B*
0-600V	0-600V	(01*)-01VA-SJSJ-B*

Product Codes – Frequency Meters 120V, Self Contained

50Hz	45-55Hz	(01*)-41SA-PNAG-AG-B*
55Hz	45-65Hz	(01*)-41SA-PNAJ-AJ-B*
60Hz	55-65Hz	(01*)-41SA-PNAN-AN-B*

Product Codes – Elapsed Time Meters 9999.99 hours, non-resettable

110/130V, 50Hz	–	(01*)-155A-PNZH-C5-B*
200/250V, 50Hz	–	(01*)-155A-RNZH-C5-B*
480V, 50Hz	–	(01*)-155A-SEZH-C5-B*
110/130V, 60Hz	–	(01*)-156A-PNZH-C6-B*
200/250V, 60Hz	–	(01*)-156A-RNZH-C6-B*
480V, 60Hz	–	(01*)-156A-SEZH-C6-B*

To denote the required case size, replace the 01* in the catalogue number with 012, 013 or 014 for 2½", 3½" or 4½" respectively.

To denote the required stud fixing configuration, replace B* with B2 (2 stud), B3 (3 stud) or B4 (4 stud)



AC Ammeter



AC Voltmeter



Frequency Meter



Features

Contoured window providing an exceptionally high viewing angle
Withstands high levels of shock, vibration, dirt and humidity

Benefits

Complies with ANSI C39.1 (IEC 51)
IP55 (NEMA 4) protection
Instruments comply with BSEN61010-1 and meet IEC414 (BS5458)
Dielectric Test (2600V for 1min)
Customised options and features

Applications

Switchgear
Distribution systems
Generator sets
Control panels
Energy management
Utility power monitoring
Process control
Motor control

Approvals

UL approved file no. E87815



016 Series Fiesta Indicators

A robust range of short-scale and long-scale 3 1/2" surface mount panel meters offering IP55 protection and featuring a wide view contoured window. The Fiesta range includes iron vane and moving coil AC and DC ammeters and voltmeters, elapsed time and frequency meters and is ideally suited for demanding environments. Options include supplementary pointer, non-reflecting window, heavily damped movement panel gasket, clamp band fixing long-scale and coloured internal gasket.

Specifications – Elapsed Time Meter and Frequency Meter

Voltage:	100/125V, 200/250V or 480V AC
Frequency:	50Hz or 60Hz
Burden:	4VA maximum
Operating temperature:	-20°C to 65°C (-4°F to 149°F)
Storage temperature:	-30°C to 70°C (-22°F to 158°F)

Specifications – Iron Vane AC Ammeter and Voltmeter

Accuracy:	Short-scale: ammeters 2.5%; long-scale: 1.5 %
Ratings:	Ammeters: short-scale 1 - 80A, long-scale 1 - 20A Volts: 10V - 600V
Overload:	Ammeters: x1.2 for 2 hours, 10 x for 5 seconds Volts: x1.2 for 2 hours, 2 x for 5 seconds
Burden:	Ammeters: short-scale 0.5VA; long-scale 1.5VA Volts: 4.5VA maximum
Operating temperature:	-20°C to 65°C (-4°F to 149°F)
Storage temperature:	-30°C to 70°C (-22°F to 158°F)

Specifications – Moving Coil DC Ammeter and Voltmeter

Accuracy:	Short-scale 1.5; long-scale 1.5
Ratings:	Ammeters: 200µA to 30A, (100µA short-scale) Volts: 50mV - 600V
Overload:	Ammeters: x1.2 for 2 hours, 10 x for 5 seconds Volts: x1.2 for 2 hours, 2 x for 5 seconds
Impedance:	Volts: 1000 ohms per nominal volt
Operating temperature:	-20°C to 65°C (-4°F to 149°F)
Storage temperature:	-30°C to 70°C (-22°F to 158°F)

Dimensions

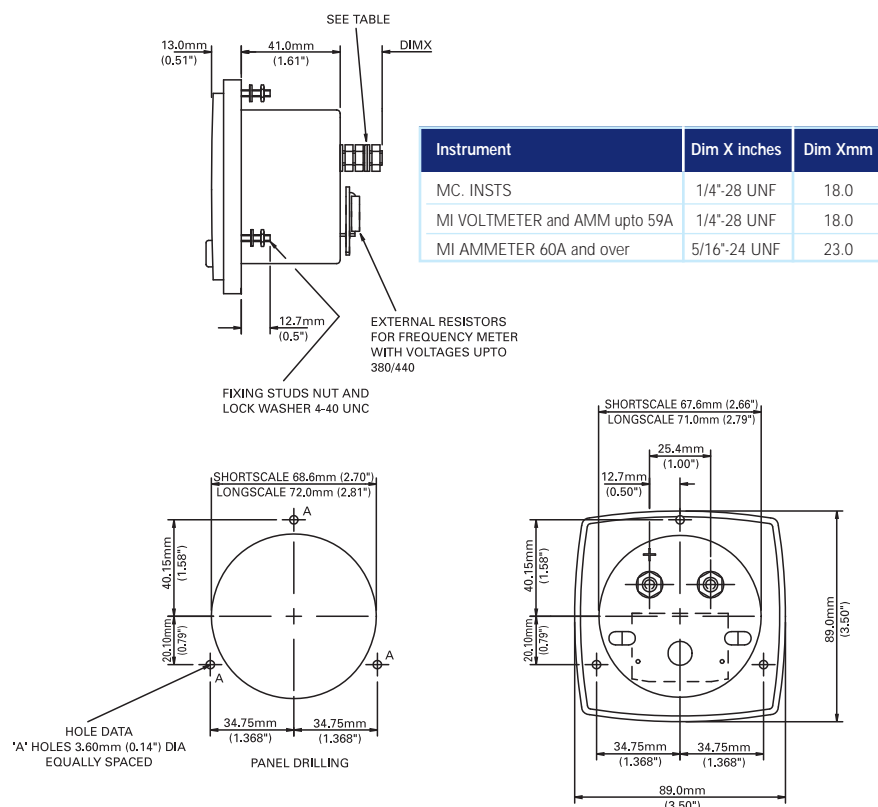

AC Ammeter

Product Codes – True RMS Reading, Self Contained 50/60Hz

Rating	Scaling	Short-scale catalogue no.	Long-scale catalogue no.
5A	0-5A	•016-02A*-LSLS-C7	016-03A*-LSLS-C7
10A	0-10A	016-02A*-MTMT-C7	016-03A*-MTMT-C7
15A	0-15A	016-02A*-NDND-C7	016-03A*-NDND-C7
20A	0-20A	016-02A*-NGNG-C7	016-03A*-NGNG-C7
30A	0-30A	016-02A*-NLNL-C7	016-03A*-NLNL-C7
5A	Transformer rated	•016-02A*-LS**-C7	016-03A*-LS**-C7

Product Codes – Moving Coil Rectified

100µA - 1A	To suit	016-01B*-	016-05B*-
------------	---------	-----------	-----------

AC Overload Ammeter

Product Codes – True RMS Reading, Self Contained 50/60Hz

Rating	Scaling	Short-scale catalogue no.	Long-scale catalogue no.
5A	0-5-30A	016-026*-LSLS-C7	016-036*-LSLS-C7
10A	0-10-60A	016-026*-MTMT-C7	016-036*-MTMT-C7
15A	0-15-90A	016-026*-NDND-C7	016-036*-NDND-C7
20A	0-20-120A	016-026*-NGNG-C7	016-036*-NGNG-C7
30A	0-30-180A	016-026*-NLNL-C7	016-036*-NLNL-C7
5A	Transformer rated	016-026*-LS**-C7	016-036*-LS**-C7

AC Voltmeter

Product Code – True RMS Reading

150V	0-150V	•016-02V*-PZPZ-C7	016-03V*-PZPZ-C7
300V	0-300V	•016-02V*-RXRX-C7	016-03V*-RXRX-C7
600V	0-600V	•016-02V*-SJSJ-C7	016-03V*-SJSJ-C7
150V	Transformer rated	•016-02V*-PZ**-C7	016-03V*-PZ**-C7

Product Code – Moving Coil Rectified

15-600V	To suit	016-01W*-	016-05W*-
---------	---------	-----------	-----------

DC Ammeters

Product Codes

150V	0-150V	•016-02V*-PZPZ-C7	016-03V*-PZPZ-C7
0-50mV	To suit	016-01A*-EC**	016-05A*-EC**
0-1mA	To suit	•016-01A*-FA**	016-05A*-FA**
0-5mA	To suit	016-01A*-FX**	016-05A*-FX**
0-10mA	To suit	016-01A*-HA**	016-05A*-HA**
0-20mA	To suit	•016-01A*-HF**	016-05A*-HF**

Suppressed Zero

Product Codes – Milliammeters - No Zero Set Unless Specified

4/20mA	To suit	•016-01RA*-HG**	016-05RA-HG**
--------	---------	-----------------	---------------

Product Codes – Voltage Suppressed Zero - No Zero Set Unless Specified

1-5V	To suit	016-01S*-LM**	-
------	---------	---------------	---

- * Please state A or B at time of ordering. A = ANSI B = BS89
- ** Customer must state required scaling at time of ordering.
- UL approved



AC Ammeter Short-scale



AC Ammeter Long-scale



AC Overload Ammeter



AC Voltmeter



DC Voltmeter



Frequency Meter



Elapsed Time Meter

DC Voltmeters

Product Codes – Sensitivity 1000Ω/Volt

Rating	Scaling	Short-scale catalogue no.	Long-scale catalogue no.
0-15V	0-15V	016-01V*-NDND	016-05V*-NDND
0-30V	0-30V	016-01V*-NLNL	016-05V*-NLNL
0-50V	0-50V	•016-01V*-NTNT	016-05V*-NTNT
0-150V	0-150V	•016-01V*-PZPZ	016-05V*-PZPZ
0-300V	0-300V	•016-01V*-RXXR	016-05V*-RXXR
0-600V	0-600V	016-01V*-SJSJ	016-05V*-SJSJ

Frequency Meters

Product Codes – 120V, Self Contained

Rating	Scaling	Short-scale catalogue no.	Long-scale catalogue no.
		Standard case	
50Hz centre frequency, -0.15 accuracy	45-55Hz	•016-41S*-PNAG-AG	
55Hz centre frequency, -0.25 accuracy	45-65Hz	•016-41S*-PNAJ-AJ	Use 016-053 plus 253-THZ
60Hz centre frequency, -0.15 accuracy	55-65Hz	•016-41S*-PNAN-AN	
400Hz centre frequency, -1.25 accuracy	360-440Hz	016-41S*-PNBI-BI	

Elapsed Time Meters

Product Codes – 99999.99 hours, Non-resettable

		Standard case	
110/130V, 50Hz	–	•016-155*-PNZH-C5	–
200/250V, 50Hz	–	•016-155*-RNZH-C5	–
480V, 50Hz	–	016-155*-SEZH-C5	–
110/130V, 60Hz	–	•016-156*-PNZH-C6	–
200/250V, 60Hz	–	•016-156*-RNZH-C6	–
480V, 60Hz	–	016-156*-SEZH-C6	–

Transducer Indicators

Product Codes – DC Milliamp Rated

Speed	To suit	016-012*	016-052
Frequency	To suit	016-013*	016-053
Phase angle	To suit	016-014*	016-054
Watts	To suit	016-015*	016-055
VArs	To suit	016-016*	016-056
VA	To suit	016-017*	–

* Please state A or B at time of ordering. A = ANSI B = BS89

** Customer must state required scaling at time of ordering.

- UL approved

Challenger Series

The Challenger range of analogue panel meters offers accurate measurement and indication of most electrical and electronic parameters in industry standard 1½", 2½", 3½" and 4½" case sizes. This innovative design features a detachable lower fascia plate, which allows the flexibility of either surface or window mounting. The fascia is simply unclipped to achieve the completely flush panel appearance of rear of panel window mounting.

The range offers AC and DC ammeters, voltmeters and frequency meters utilising a high torque pivot and jewel movement. AC moving coil rectified meters provide 1.5% accuracy of the full scale value and feature a rear zero adjuster screw for tamperproof installation. AC moving iron meters also provide 1.5% high accuracy and true RMS measurement.

Operation

The Challenger series utilises a traditional pivot and jewel movement, incorporating specially hardened steel pivots and a spring loaded jewel. This robust mechanism is ideally suited for all applications, including the most demanding conditions.

Moving Coil Meters

These meters offer a centre cored, self-shielding moving coil movement using pivots, hairsprings and sprung jewels. Variations in movement are limited by design. All DC voltmeters are 1000 ohms per volt, moving coil rectified products run at 900 ohms per volt. Millivolt meters use a 5 milliamps/50mV movement.

Moving Iron Meters

This clapper type repulsion design utilises a pivot, hairspring and jewel movement. The bottom jewel is oil filled to provide damping while the top is sprung for resilience. All voltmeters are manufactured with internal voltage dropper resistors.

Frequency Meters

Frequency meters utilise a 1mA/35ohm DC moving coil movement driven by an EMC hard frequency conversion circuit.

Dials, Pointers and Scales

Standard dials are matt white with black printed scales and a tubular knife-edge black matte pointer. The 90° scales are balanced within 1% of scale length and feature a highly repeatable flattened arc scale shape, ensuring consistently accurate measurement readings. Dials are interchangeable between the Challenger series for inputs within the published meter specifications of the meter. Options for non standard customised dials are available upon request.

Current Transformers and Shunts

Crompton Instruments, a Business Unit of Tyco Electronics, offers a comprehensive range of current transformers and shunts, for driving the Challenger panel meters for the safe and simple measurement of AC and DC currents.

Our extensive range of current transformers provides accurate measurement of AC current and ratio matching to a consistent 5 or 1 amp secondary current, proportional to the primary current.

Our range of shunts ensures a DC millivolt signal exactly proportional to the system current for driving ammeters, providing accurate measurement of DC current up to 12000A, with secondary inputs of, 50, 60, 75 or 100mV DC to match the Challenger input.



Features

- Measurement and indication of AC amps, volts, frequency and DC signals
- Surface or window mounting
- Rear zero adjuster on moving coil meters
- High torque pivot and jewel movement
- True RMS measurement meters
- AC and DC inputs
- Up to 40A DC direct connected
- Up to 50A AC direct connected

Benefits

- AC moving iron and moving coil mechanisms
- Reduced inventory
- 4 ANSI standard case sizes
- Detachable lower fascia plate
- Easy to modify for distributors
- Through holes for back of panel mounting

Applications

- Marine panels
- Switchgear
- Distribution systems
- Control panels
- Embedded generation
- Energy management
- Building management
- Utility power monitoring
- Process control
- Motor monitoring

Compliant with

- ANSI C39.1 1981
- IEC 51
- UL3111-1
- EMC
- LVD
- UL and CUL file no: E236986



Model 361 (1 1/2")



Model 362 (2 1/2")



Model 363 (3 1/2")



Model 364 (4 1/2")



Specifications

Accuracy		
DC ammeters and voltmeters	1.5%	0-100% of full scale deflection
AC ammeters and voltmeters	Moving iron: 1.5% Moving coil: 1.5%	10 -100% of full scale deflection 10-100% of full scale deflection
Frequency meters	0.5% of end scale value	
Input ratings		
DC moving coil ammeters	50µA - 40A DC. (Model 361: 10A max)	
DC moving coil voltmeters	50mV - 600V DC	
DC moving coil centre zero ammeters	+/-50mA to +/-40A DC. (Model 361: 10A max)	
DC moving coil centre zero voltmeter	+/-50mV to +/-600V DC. Standard 1k ohm/volt	
DC moving coil suppressed zero ammeters	4/20mA DC	
DC moving coil suppressed zero voltmeters	1/5, 8/16, 16/32 or 12/24 V DC	
AC moving coil ammeters	100µA - 750mA AC	
AC moving coil voltmeters	20 - 600V AC. Standard 900ohms/volt	
AC moving iron ammeters	1 - 50A AC (Model 361: non applicable)	
AC moving iron voltmeters	3 - 600V AC (Model 361: non applicable)	
Frequency	100/130V, 200/250V, 360/440V, 50Hz, 60Hz or 400Hz (Model 361: non applicable)	
Burden	Ammeter 0.5VA Voltmeter: 4.5VA Frequency: 4VA	
Overload	1.2 continuous x 10 for 0.5 seconds	
Enclosure		
Movement	High torque pivot and jewel moving coil and moving iron	
Scale balance	Within 1% of scale length	
Relative humidity	25% - 80% nominal range of use	
Operating temperature	0°C to 40°C (-32°F to 104°F)	
Storage temperature	-20°C +55°C (-4°F to 131°F)	
Case and lower mask	Black matte case UL94V. Polycarbonate cover	
Window	Shatterproof polycarbonate	
Surface mounting	4 corner studs	
Rear of panel mounting	2 through hole mounts (Model 361: facility pending)	
Compliant with		
UL and CUL	61010B-1 File no: E236986	
Performance	ANSI C39.1 1981 and IEC 51	
Scaling	ANSI C39.1 1981	
Safety	IEC61010-1 (LVD) and BS EN 61326:1998 (EMC)	
Vibration	ANSI C39.1 1981 cl. 5.13	

Product Codes

Input	Model 361 cat. no.	Model 362 cat. no.	Model 363 cat. no.	Model 364 cat. no.
DC moving coil amps	361-01A	362-01A	363-01A	364-01A
DC moving coil volts	361-01V	362-01V	363-01V	364-01V
DC moving coil centre zero amps	361-01C	362-01C	363-01C	364-01C
DC moving coil centre zero volts	361-01N	362-01N	363-01N	364-01N
DC moving coil suppressed zero amps	361-01R	362-01R	363-01R	364-01R
DC moving coil suppressed zero volts	361-01S	362-01S	363-01S	364-01S
AC moving coil amps	361-01B	362-01B	363-01B	364-01B
AC moving coil volts	361-01W	362-01W	363-01W	364-01W
AC moving iron amps	N/A	362-02A	363-02A	364-02A
AC moving iron volts	N/A	362-02V	363-02V	364-02V
Frequency	N/A	362-41S	363-41S	364-41S

Please specify current, voltage, frequency and required options at time of ordering.

Connections

DC Amps – Self contained

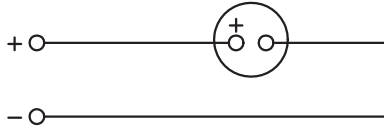

DC Amps – For use with external shunt

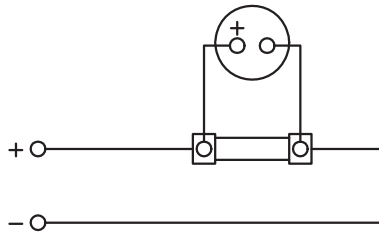

DC Volts

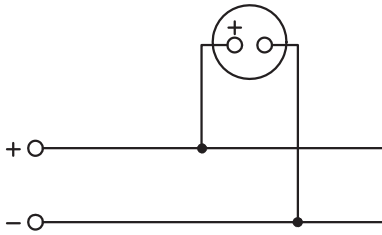

AC Amps – Self contained

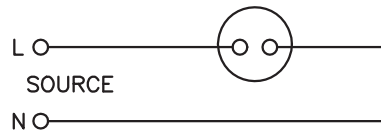

AC Amps – For use with current transformer

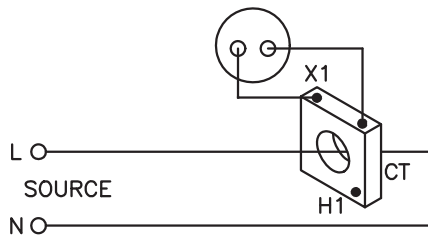

AC Volts

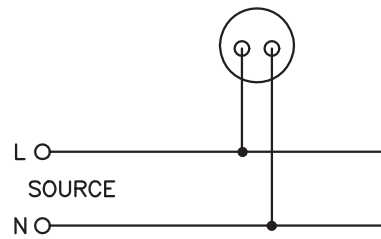

Frequency Meter

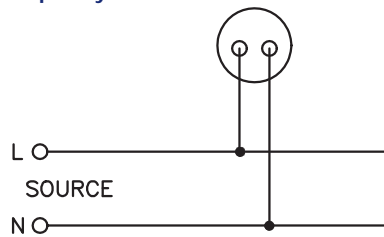

Dimensions – Surface Mount

Model 361

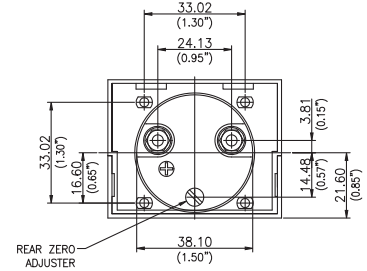
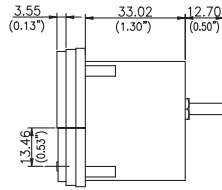
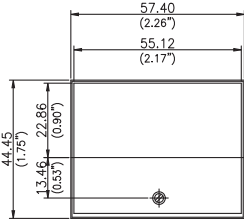

Model 362

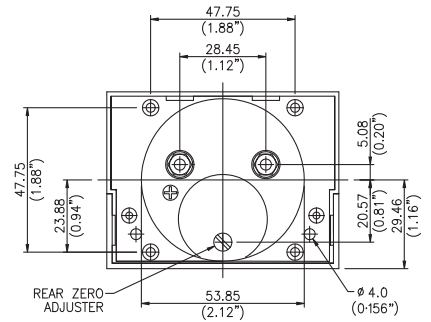
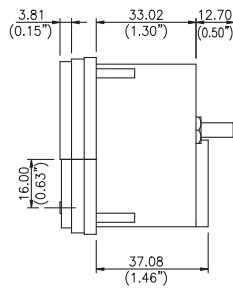
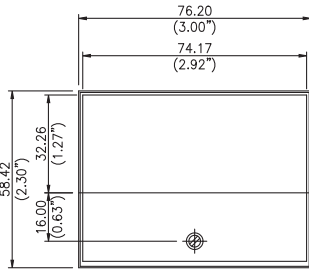

Model 363

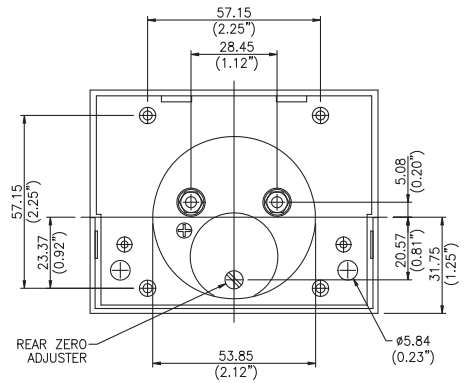
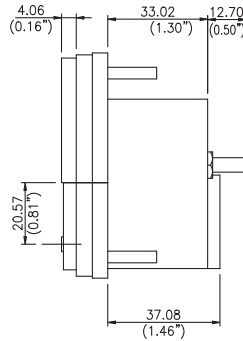
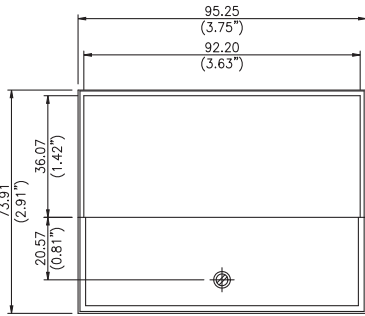

Model 364

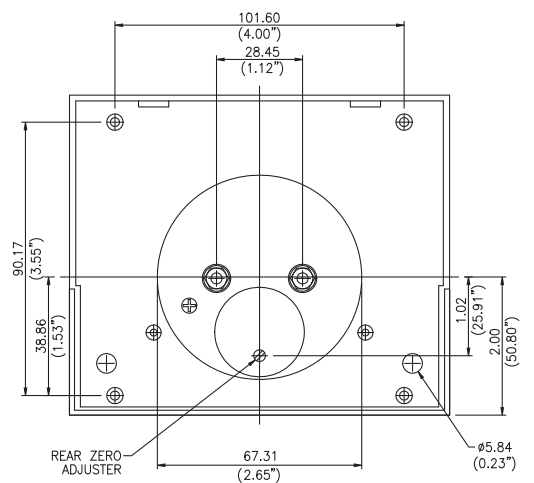
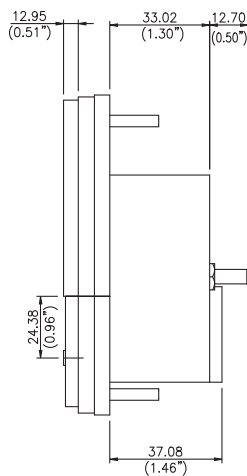
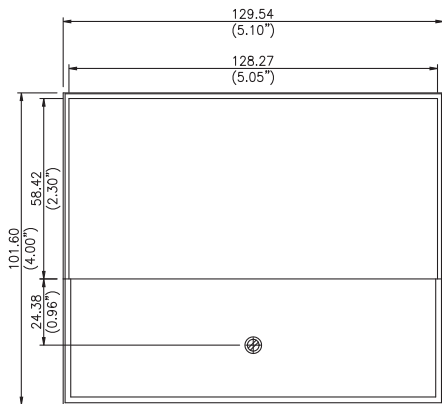

Dimensions – Panel Mount

Model 361
Surface Mount Cut-out

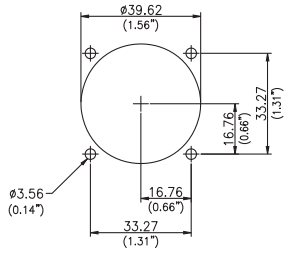

Window Mount Cut-out

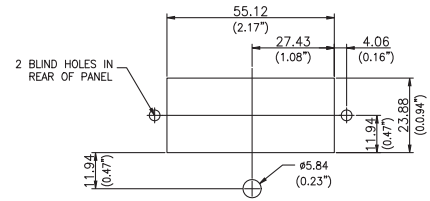

Model 362
Surface Mount Cut-out

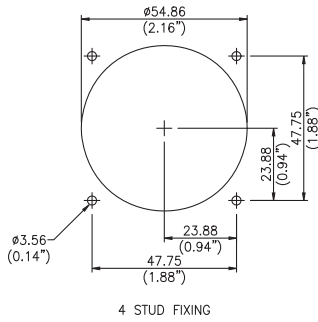

Window Mount Cut-out

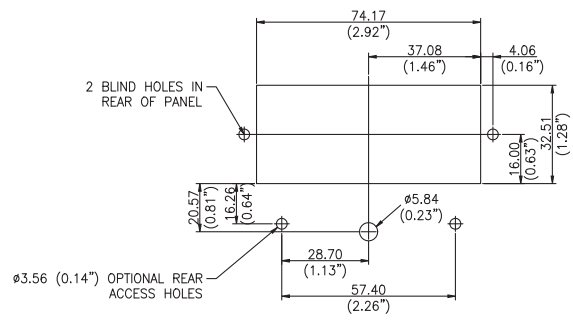

Model 363
Surface Mount Cut-out

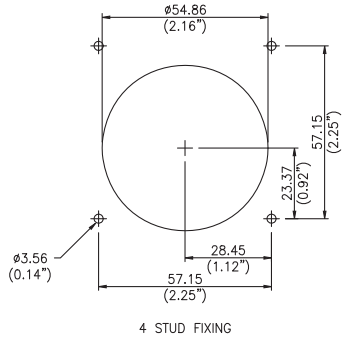

Window Mount Cut-out

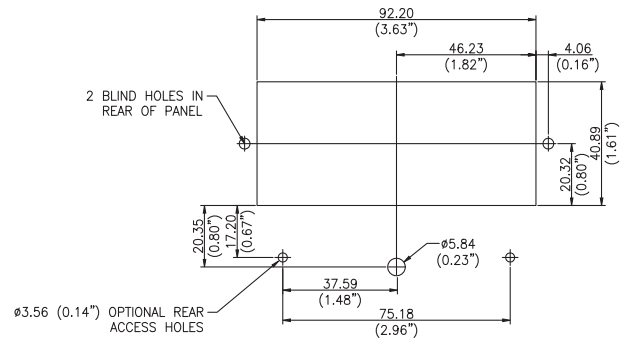

Model 364
Surface Mount Cut-out

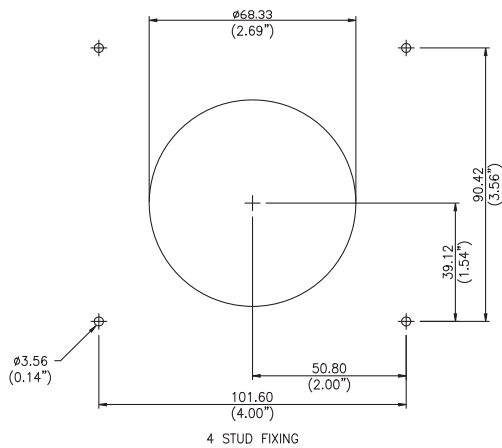

Window Mount Cut-out

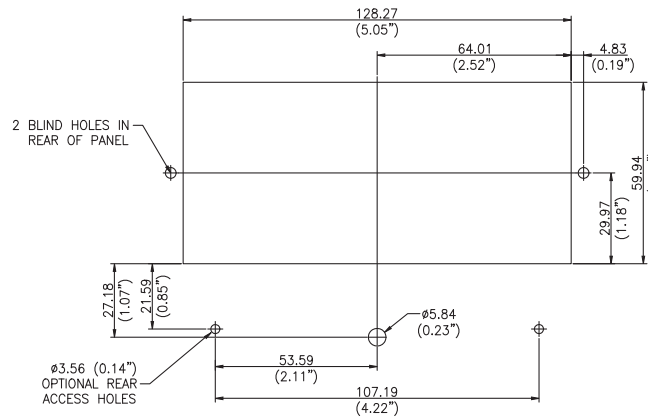

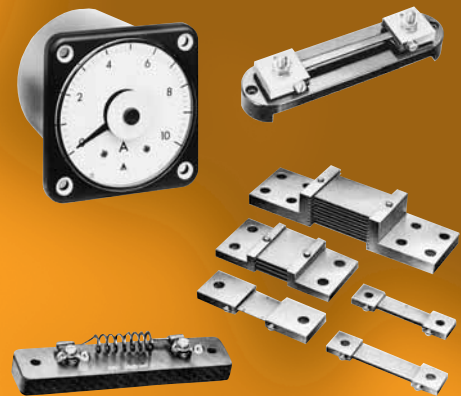

Sealed and Ruggedised Indicators

078/080/087 Series 240° Scale

The Crompton Instruments 078/080/ 087 series of heavy duty sealed instruments are designed to comply with the most stringent industrial, marine and military specifications.

This metal cased range offers bezel sizes of 57mm, 83mm and 110mm all fitted with toughened glass. Indicators comply with Ministry of Defence specification DEF STAN 66.7. and operate efficiently in the most adverse environments where extreme conditions of shock, vibration, dirt, humidity and temperature variation are present.

Features

Designed specifically for stringent industrial, marine and military specifications

An extensive range of high accuracy measuring instruments in 3 case sizes

Rugged Hi-Q taut-band suspension

Bump, shock and vibration proof

Benefits

Complies with BS EN 60051 (IEC51)

IP67 (NEMA 6 and 6P) protection

Dial illumination option

Parallax error-free platform dials for 078/087. Optional for 083/084

Applications

Switchgear

Distribution systems

Generator sets

Control panels

Utility power monitoring

Process control

Motor control

Marine

Military

Approvals

DEF STAN 66.7

Intrinsically safe options to EEx ia 11C T4

Description

Indicators have metal cases with bezel sizes of 50 x 57mm (083), 83mm Ø (084) and 110mm x 100mm (078/087). All indicators are fitted with toughened glass windows. The standard black matte finish can be replaced with options ranging from light admiralty grey to BS3181C No:697. To prevent fogging, all indicators have been dried, evacuated and filled with dry nitrogen during manufacturing. The case interior retains a constant pressure of at least 94kPa above the exterior with leakage not above the equivalent of 1.33 Pa ml/s of air. Except on model 083, panel sealing gaskets are standard equipment.

Standard instrument dials are finished in acrylic white matte with black printing and a parallel pointer. Scales form a true arc with zero on the left hand-side. Options include dial illumination, a centre, off-set or suppressed zero, colour index lines, bands, zones or segments, a black dial with white printing, and customer logo.

Specifications

Performance:	BS EN60051 (IEC51) DEF STAN 66-7 on request (087 only)
Accuracy:	Refer to Product Range table
Scaling:	BS89, BS3693 or DEF STAN 66-7 and 66-9
Dielectric test:	2kV r.m.s to BSEN61010-1
Overloads:	x 1.2 rated current for 2 hours x 10 rated current for 5 seconds x 1.2 rated voltage for 2 hours x 2 rated voltage for 5 seconds
Enclosure code:	IP67 (NEMA 6 and 6P)
Case:	Black matte metal filled with dry nitrogen
Bezel:	Black matte metal. Optional admiralty grey No. 697
Bezel window:	Toughened glass
Operating temp.:	-40°C to +70°C (-40°F to +158°F)
Storage temp.:	-55°C to +85°C (-67°F to 185°F)
Standard calibration:	23°C (73°F)
Approvals:	EMC and LVD. DEF 66.7 Intrinsically safe option to EEx ia 11C T4

Product Range – 078/080/087 Series 240° Scale

Type of instrument	Ranges	Accuracy class	Burden VA	Case code				Product code
				depth behind the bezel				
AC ammeter moving iron	0.75-20A	2.5	2	57	-	-	-	083-03A
AC ammeter moving iron	0.75-20A	1.5	2	-	59	-	-	084-03A
AC ammeter moving iron	0.5-30A	1.5	2	-	-	86	-	078-08A
AC ammeter moving iron	0.5-30A	1.5	2	-	-	-	86	087-08A
AC voltmeter moving iron	5-800V	2.5	5	57	-	-	-	083-03V
AC voltmeter moving iron	5-800V	1.5	5	-	59	-	-	084-03V
AC voltmeter moving iron	5-800V	1.5	5	-	-	86	-	078-08V
AC voltmeter moving iron	5-800V	1.0	5	-	-	-	86	087-08V
DC ammeter shunt operated	50, 60, 75, 100, 150mV	2.5	See T118***	57	-	-	-	083-05A
DC ammeter shunt operated	50, 60, 75, 100, 150mV	1.5	See T118***	-	59	-	-	084-05A
DC ammeter shunt operated	50, 60, 75, 100, 150mV	1.5	See T118***	-	-	86	-	078-05A
DC ammeter shunt operated	50, 60, 75, 100, 150mV	1.5	See T118***	-	-	-	86	087-11A
DC ammeter	200µA-30A	2.5	See T118***	57	-	-	-	083-05A
DC ammeter	200µA-30A	1.5	See T118***	-	59	-	-	084-05A
DC ammeter	200µA-30A	1.0	See T118***	-	-	86	-	078-05A
DC ammeter	200µA-30A	1.0	See T118***	-	-	-	86	087-11A
DC ammeter suppressed zero	4/20mA	2.5	See T118***	57	-	-	-	083-05R
DC ammeter suppressed zero	4/20mA	1.5	See T118***	-	59	-	-	084-05R
DC ammeter suppressed zero	4/20mA	1.5	See T118***	-	-	86	-	078-05R
DC ammeter suppressed zero	4/20mA	1.5	See T118***	-	-	-	86	087-11R
DC voltmeter	50mV-600V	2.5	See T118***	57	-	-	-	083-05V
DC voltmeter	50mV-600V	1.5	See T118***	-	59	-	-	084-05V
DC voltmeter	50mV-800V	1.5	See T118***	-	-	86	-	078-05V
DC voltmeter	50mV-800V	1.0	See T118***	-	-	-	86	087-11V
DC voltmeter suppressed zero	1/5V	1.5	See T118***	-	-	86	-	078-05S
DC voltmeter suppressed zero	1/5V	1.5	See T118***	-	-	-	86	087-11S
AC rectified ammeter	200µA-1A	2.5	See T118***	57	-	-	-	083-05B
AC rectified ammeter	200µA-1A	2.5	See T118***	-	59	-	-	084-05B
AC rectified ammeter	200µA-30A	1.5	See T118***	-	-	86	-	078-05B
AC rectified ammeter	200µA-30A	1.5	See T118***	-	-	-	86	087-11B
AC rectified voltmeter	15-600V 25Hz/3kHz	2.5	See T118***	57	-	-	-	083-05W
AC rectified voltmeter	15-600V 25Hz/3kHz	2.5	See T118***	-	59	-	-	084-05W
AC rectified voltmeter	15-600V 25Hz/3kHz	1.5	See T118***	-	-	86	-	078-05W
AC rectified voltmeter	15-600V 25Hz/3kHz	1.5	See T118***	-	-	-	86	087-11W
Elapsed time meter	50 or 60Hz, 100-400V*			57	-	-	-	083-155 or 156
Elapsed time meter	12, 24V DC			57	-	-	-	083-151
Elapsed time meter	50 or 60Hz, 100-400V*			-	59	-	-	084-155 or 156
Elapsed time meter	12, 24V DC			-	59	-	-	084-151
Elapsed time meter	50 or 60Hz, 100-400V*			-	-	86	-	078-155 or 156
Frequency meter	50/60/400Hz 100-440V*	0.5%	4	57	-	-	-	083-41S
Frequency meter	50/60/400Hz 100-440V*	0.5%	4	-	59	-	-	084-41S/089-41S
Frequency meter	50/60/400Hz 100-440V*	0.5%	4	-	-	86	86	078/087-41L
Temperature indicator	RTD	1.5	See T118***	-	-	86	-	078-45 R
Wattmeter or VArmeter	0.2-10A/100-440V*	Balanced	Current	-	-	132	132	078/087-21 or 31
360° power factor meter	1 or 5A 100-440V* 50 or 60Hz	2°		-	-	132	132	078-13
360° power factor meter	1 or 5A 100-440V* 50, 60 or 400Hz	2°		-	-	132	132	087-13
360° rotary synchroscope	100/125V, 200/250 380/450**	2°		-	-	132	132	078/087-14
Transducer operated indicator	1, 5, 10, 20 or 4/20mA	1.0	See T118***	57	-	-	-	083-05
Transducer operated indicator	1, 5, 10, 20 or 4/20mA	1.0	See T118***	-	59	-	-	084-05
Transducer operated indicator	1, 5, 10, 20 or 4/20mA	1.0	See T118***	-	-	86	-	078-05
Transducer operated indicator	1, 5, 10, 20 or 4/20mA	1.0	See T118***	-	-	-	86	087-11

* 100-440V = (100/125, 200/250, 380/440)

*** The T118 technical sheet is available on request.

** Using transformer box 855-954.

For specification and connection diagrams, please refer to equivalent models in the 240 Series DIN Panel Meter section. Replace 244 with 078 etc., e.g. 244-210 becomes 078-210.



Sealed and Ruggedised Indicators

080 Series 90° Scale

A range of metal case, sealed instruments for industrial and military applications involving extreme shock, vibration, temperature, dirt and humidity. Bezel sizes 32mm, 45mm, 57mm, 83mm comply with Ministry of Defence specification DEF STAN 66-7 or DEF STAN 66-9 for all standard ratings. Bezel size 89mm complies with MIL-M-10304 dimensions.

Features

Designed specifically for stringent industrial, marine and military specifications

An extensive range of high accuracy measuring instruments in 5 case sizes

Rugged Hi-Q taut-band suspension

Bump, shock and vibration proof

Benefits

Complies with BS EN 60051 (IEC51) for models 081 to 084

IP67 (NEMA 6 and 6P) protection for models 083/084 and 089

IP68 for models 081 and 082

Dial illumination options

Applications

Switchgear

Distribution systems

Generator sets

Control panels

Energy management

Utility power monitoring

Process control

Motor control

Industrial, marine and military specifications

Approvals

DEF STAN 66.7 and 66.9
(Models 081, 084 and 089)

Description

Five bezel sizes of 32mm Ø (081), 45mm Ø (082), 57 x 57mm (083), 83mm Ø (084) and 89mm Ø (089) with barrel diameters of 26mm (081), 37mm (082), 53mm (083), and 67mm (084 and 089) and toughened glass windows are used throughout the series.

To avoid fogging they are dried, evacuated and filled with dry nitrogen. Panel sealing gaskets are provided as standard with the exception of Model 083. The smaller cases on Models 081 and 082, are made from nickel-plated brass and anodised aluminium alloy. Single hole fixing is made with threaded clamp ring which screws onto the barrel, they also have ceramic insulated terminals and no zero adjuster is fitted. Models 083, 084 and 089 have steel cases with fixing holes in the flange. Sealed zero adjusters are provided. Standard instrument dials are finished in a white matte with black printing and parallel pointer. The scales form a true arc with zero on the left.

Options

Available options include dial illumination, a centre, off-set or suppressed zero, colour index lines, bands, zones or segments, a black dial with white printing and customer logo. Instruments operated by separate transducers indicate watts, VAR, frequency, phase angle, current, voltage and other physical/mechanical parameters are also available. Illumination options as follows:

Model 081: Through-dial, white or red bulb, 12 or 24V illumination.

Models 081/082: Betalite through-dial, 12 or 24V, illumination.

Models 082/083/084/089: Through-dial, red or clear LED, 12 or 24V illumination.

Models 083/084/089: Edge, white or red bulb, 12 or 24V, illumination.

Specifications

Performance:	BS EN60051 (IEC51) for models 081 to 084 DEF STAN 66-7 and 66.9 on request (081/084 and 089)
Accuracy:	Model 081: Class 5. Others: Class 2.5 Frequency meter 0.5% of mid frequency (083, 084, 089)
Scaling:	To BS89, BS3693 or DEF STAN 66-7 and 66-9 (081 to 084)
Dielectric test @ 50 Hz:	750V RMS (081); 1kV RMS (082); 2kV RMS (083/084/089); <50V 500V RMS All for 1 minute
Overloads:	x 1.2 rated current or voltage for 2 hours x 10 rated current for 5 seconds x 2 rated voltage for 5 seconds
Burden:	AC ammeter: 1VA maximum AC voltmeter: 3VA maximum Frequency meter: 4VA maximum Elapsed time meter: 2.5VA maximum
Enclosure code :	083/084/089: to IP67 (NEMA 6 and 6P) 081/082: to IP68
Case:	081/084 and 089: Black matte metal filled with dry nitrogen 081 and 082: Nickel-plated brass and anodised aluminium alloy.
Bezel:	Black matte metal
Bezel window:	Toughened glass
Operating temp.:	Model 081 to 084: -40°C to +70°C (-45F to +158°F) Model 089: -55°C to 65°C (-67°F to +185°F)
Standard calibration:	23°C (73°F)
Approvals:	EMC and LVD. DEF 66.7 and 66.9



Product Range – 080 Series 90° Scale

Type of instrument	Ranges	Case code					Product code
		081	082	083	084	089	
AC ammeter moving iron	1-30A	-	-	✓	-	-	083-75A
AC ammeter moving iron	1-30A	-	-	-	✓	-	084-75A
AC ammeter moving iron	1-30A	-	-	-	-	✓	089-75A
AC voltmeter moving iron	5-300V	-	-	✓	-	-	083-75V
AC voltmeter moving iron	5-500V	-	-	-	✓	-	084-75V
AC voltmeter moving iron	5-500V	-	-	-	-	✓	089-75V
DC ammeter shunt operated	50, 60, 75, 100, 150mV	✓	-	-	-	-	081-80A
DC ammeter shunt operated	50, 60, 75, 100, 150mV	-	✓	-	-	-	082-80A
DC ammeter shunt operated	50, 60, 75, 100, 150mV	-	-	✓	-	-	083-80A
DC ammeter shunt operated	50, 60, 75, 100, 150mV	-	-	-	✓	-	084-80A
DC ammeter shunt operated	50, 60, 75, 100, 150mV	-	-	-	-	✓	089-80A
DC ammeter	50µA-20mA	✓	-	-	-	-	081-80A
DC ammeter	50µA-10A	-	✓	-	-	-	082-80A
DC ammeter	50µA-30A	-	-	✓	-	-	083-80A
DC ammeter	50µA-30A	-	-	-	✓	-	084-80A
DC ammeter	50µA-30A	-	-	-	-	✓	089-80A
DC ammeter suppressed zero	4/20mA	✓	-	-	-	-	081-80R
DC ammeter suppressed zero	4/20mA	-	✓	-	-	-	082-80R
DC ammeter suppressed zero	4/20mA	-	-	✓	-	-	083-80R
DC ammeter suppressed zero	4/20mA	-	-	-	✓	-	084-80R
DC voltmeter	50mV-300V	✓	-	-	-	-	081-80V
DC voltmeter	50mV-300V	-	✓	-	-	-	082-80V
DC voltmeter	50mV-300V, 1000Ω/V	-	-	✓	-	-	083-80V
DC voltmeter	50mV-300V	-	-	-	✓	-	084-80V
DC voltmeter	50mV-300V	-	-	-	-	✓	089-80V
DC voltmeter suppressed zero	1/5V	-	✓	-	-	-	082-80S
DC voltmeter suppressed zero	1/5V	-	-	-	✓	-	084-80S
AC rectified ammeter	100µA-500mA.25Hz/3kHz	-	✓	-	-	-	082-80B
AC rectified ammeter	100µA-500mA.25Hz/3kHz	-	-	✓	-	-	083-80B
AC rectified ammeter	100µA-500mA.25Hz/3kHz	-	-	-	✓	-	084-80B
AC rectified voltmeter	15-300V	-	✓	-	-	-	082-80W
AC rectified voltmeter	15-600V, 900Ω/V	-	-	✓	-	-	083-80W
AC rectified voltmeter	15-600V	-	-	-	✓	-	084-80W
AC rectified voltmeter	15-600V	-	-	-	-	✓	089-80W
Elapsed time meter (99999.9)	12 or 24V DC	-	✓	✓	✓	-	082/083/084-151
Elapsed time meter (99999.9)	50Hz / 100-440V*	-	-	✓	✓	-	083/084-155
Elapsed time meter (99999.9)	60Hz / 100-440V*	-	-	✓	✓	-	083/084-156
Elapsed time meter (99999.9)	50Hz / 100-440V*	-	-	-	-	✓	089-155
Elapsed time meter (99999.9)	60Hz / 100-440V*	-	-	-	-	✓	089-156
Frequency meter	50 or 60 or 400Hz/100-440V*	-	-	✓	-	-	083-41S
Frequency meter	50 or 60 or 400Hz/100-440V*	-	-	-	✓	-	084-41S
Frequency meter	50 or 60 or 400Hz/100-440V*	-	-	-	-	✓	089-41S
Transducer indicator speed	1, 5, 10, 20, and 4/20mA				✓		084/802
Transducer indicator frequency	1, 5, 10, 20, and 4/20mA				✓		084/803
Transducer indicator phase angle	1, 5, 10, 20, and 4/20mA				✓		084/804
Transducer indicator watts	1, 5, 10, 20, and 4/20mA				✓		084/805
Transducer indicator VArS	1, 5, 10, 20, and 4/20mA				✓		084/806
Transducer indicator VA	1, 5, 10, 20, and 4/20mA				✓		084/807

*100-440V – (100/125 or 200/250 or 380/440)



Dimensions

Model 081

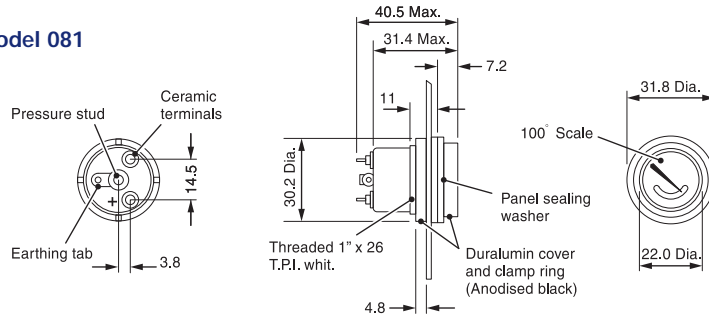

Model 082

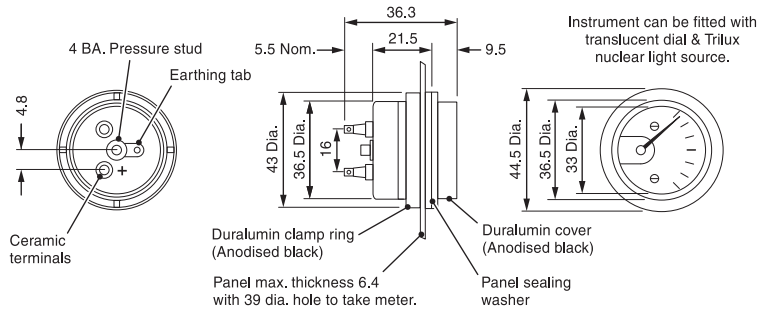

Model 083

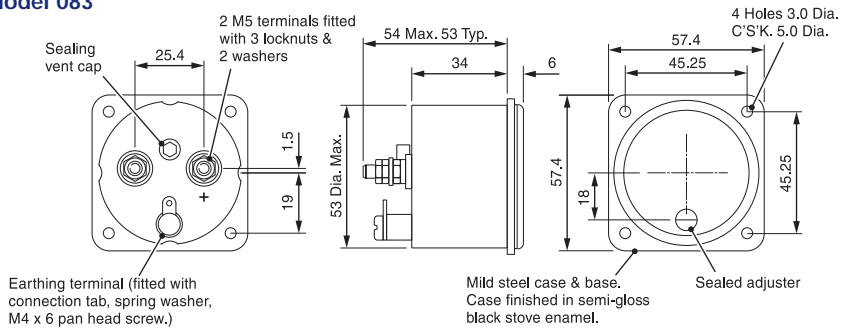

Model 084/089

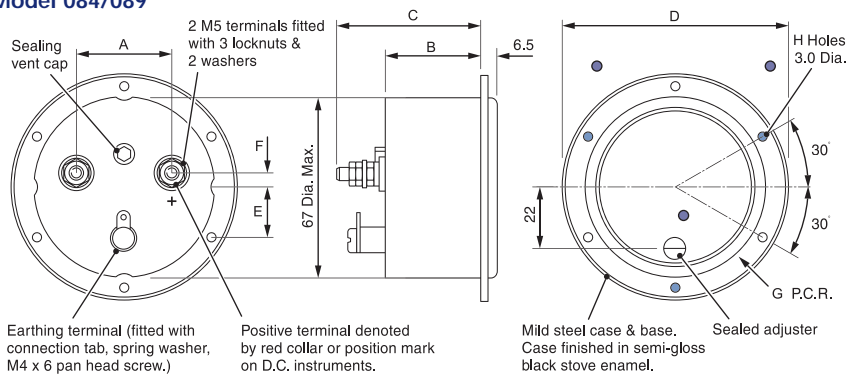

*When fitted with terminal shunt for ranges above 20 amps.

	A	B	C	D	E	F	G	H
084-80	35	33.5	59	82.5	20	5	36.5	6 off
089-80	35	33.5	59	88.9	20	5	36.5	3 off
084-75	35	38	64	82.5	20	5	36.5	6 off
089-75	35	38	64	88.9	20	5	36.5	3 off

Panel Cut out 68.3ø – Holes 3.8ø
 These ● holes on 084 only.

Catalogue Numbering System

Guide to Catalogue Numbering System – Example Code: 244 – 03AG – LSPK – C6 – ER

244	03	A	G	LS	PK	C6	ER
SERIES 016 – Fiesta 075 – Short-case switchboard 077 – Standard switchboard 078 – Hi-shock sealed 079 – 8 ^{3/4} " switchboard 083 – 2" sealed 084 – 2 ^{1/2} " sealed 242 – 48mm DIN 243 – 72mm DIN 244 – 96m DIN 246 – 144mm DIN E242– 48mm short-scale E243– 72mm short-scale E244– 96mm short-scale	TYPE / FUNCTION A – Amperes DC B – Rectified amperes C – Center zero amps D – Zero offset current F – Amperes AC G – Volts AC H – High middle K – DC input non electrical scaling L – VAr self contained N – Center zero voltage P – Zero offset voltage R – Live zero current S – Live zero voltage V – Volts DC W – Rectified voltage Y – Expanded scale AC Z – Expanded scale DC 2 – 2 x overload ammeters 3 – 3 x overload ammeters 5 – 1-phase 2-wire watts 6 – 6 x overload ammeters 8 – 3-phase 3-wire watts 9 – 3-phase 4-wire watts	INPUT OR MOVEMENT RATING LA – 1A LS – 5A PZ – 150V RX – 300V SJ – 600V PN – 120V RP – 240V SE – 480V QQ – 120V 5A QS – 240V 5A QT – 480V 5A etc	SYSTEM FREQUENCY (AC Meters) C4 – 400Hz C5 – 50Hz C6 – 60Hz C7 – 50/60Hz	OPTIONS Indicate as required	MOVEMENT CODE 01 – Short-scale AC and DC 02 – Short-scale AC 03 – Long-scale AC and DC 05 – Long-scale AC and DC 07 – Edgewise AC DC 08 – Long-scale AC 10 – Edgewise AC and DC 11 – Long-scale DC 12 – Phase sequence meter 13 – 360 rotating iron PFI 14 – Synchroscope 15 – Elapsed time meter 16 – Thermal demand ammeter 21 – Wattmeter 30 – Meter relay 31 – VArmeter 41L – Frequency meter long-scale 41S – Frequency meter short-scale 42 – Power factor meter 45 – RTD temperature 92 – Shunts 94 – Current transformers HW – Kilowatt hour class 1.0 KH – Kilowatt hours KW – Kilowatt hours class 2.0	NATIONAL STANDARD A – ANSI C39.1 B – BS 89 G – DIN I – ANSI fixing captions J – Japanese instrument Standard	SCALING OR OUTPUT BX – Volt free relay contacts FA – 1mA HG – 4/20mA PK – 0/100 PZ – 0/150 RL – 0/200 RX – 0/300 SC – 0/400 SJ – 0/600 SS – 0/1000 TM – 0/2000 UB – 0/4000 UJ – 0/5000 etc

This guide is not inclusive of all catalogue numbers and should be used for reference only, as improper combinations can be achieved.

Glossary

Glossary of Terms

MI	Moving iron, also called 'iron vane' in the North American market for measuring AC amps and volts.
MC	Moving coil for measuring DC amps and volts.
Taut band suspension movement	A meter movement held under tension, usually on a ligament.
Ligament	The taut band.
Pivot and jewel (P&J)	A movement which rotates on a spindle, and pivots within an oil filled jewel. This type of movement typically offers excellent vibration resistance characteristics.
Short-scale	Angle of deflection for a movement is usually 90 degrees but ANSI is 100 degrees in some products.
Long-scale	Angle of deflection for a movement is usually 240 degrees but is frequently referred to as 270 degree.
FSD	Full scale deflection.
ES	End scale.
Input	Electrical value from which the measurement is derived to achieve the full scale deflection of the movement.
Linear	A term used to state that the input is constant, allowing for an even scaling.
Non linear	The opposite of linear, giving a scale shape which will cramp at some point on the dial. Usually inaccurate below 20% of the full-scale value.
Logarithmic scaling	A log scale usually derived from a non linear DC output.
Scale	The graphical representation of the value being measured.
Dual arc	More than one set of figures on a dial plate.
Dial plate/scale plate	Surface on which the dial is drawn.
Calibration chart	A chart matching input values to scale mark, mainly used for complicated scales.
Enclosure rating	Usually expressed in the form of IP rating or as NEMA in America. This states the product, resistance to the ingress of moisture and dust.
DIN	European standard meter shape. It is based on multiples of 24mm, i.e. 48, 72, 96, 144 mm.
ANSI	American National Instrument Standard.
JIS	Japanese Instrument Standard.
BS89	Old British Standard usually refers to rectangular meter or "Fiesta" style products.
Switchboard meter	General term for long-scale instruments.
Panel meter	General name for short-scale instruments.
Analogue indicator	Generic term for instruments usually refers to a low accuracy meter. An indicator only.



tyco

Electronics

Tyco Electronics UK Limited, Crompton Instruments
Freebournes Road, Witham, Essex, CM8 3AH, UK
Phone: ++44 (0)870 870 7500
Fax: ++44 (0)870 240 5287
www.tycoelectronics.com

All of the above information, including drawings, illustrations and graphic designs, reflects our present understanding and is to the best of our knowledge and belief correct and reliable. Users, however, should independently evaluate the suitability of each product for the desired application. Under no circumstances does this constitute an assurance of any particular quality or performance. Such an assurance is only provided in the context of our product specifications or explicit contractual arrangements. Our liability for these products is set forth in our standard terms and conditions of sale. Paladin and CROMPTON are trademarks of Crompton Parkinson Ltd. and is used by Tyco Electronics under licence.

a vital part of your world

© Tyco Electronics CI-EPP-UK-ANALOGUE-11/09

Energy Products – economical solutions for the electrical power industry: cable accessories, connectors & fittings, electrical equipment, instruments, lighting controls, insulators & insulation enhancement and surge arresters.